

S-AFCII SUPER AIRFLOW CONVERTER

SUPER AIR FLOW CONVERTER II WIRING DIAGRAM BY MODEL

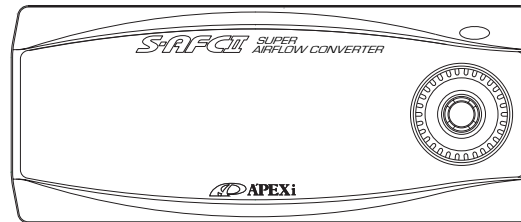

This document describes car models to which the Super Airflow Converter (Product code: 401-A911/401-A913) is applicable, and ECU terminal arrangement drawings. For the operating method and precautions for the Super Airflow Converter, refer to the Instruction Manual.

When installing the Super Airflow Converter, both this document and the Instruction Manual are required.

Even if the car model and manufacturing year coincide with the contents described in this document, this product may not be installed in certain specification vehicles or remodeled vehicles. The manufacturing years of applicable vehicles are as of January, 2005. For the latest vehicles applications, Please contact your local APEX Office or dealer for more information.

■ Contents

■ Introduction	P3
■ Precaution on Installation	P4
■ Installation	P6
■ ECU Arrangement Diagram	P12
■ How to Refer to the ECU Terminal Arrangement Diagram ..	P13
■ TOYOTA	
Table of Applicable Models	P14
ECU Terminal Arrangement Table	P22
■ NISSAN	
Table of Applicable Models	P28
ECU Terminal Arrangement Table	P33
■ HONDA	
Table of Applicable Models	P37
ECU Terminal Arrangement Table	P41
■ MITSUBISHI	
Table of Applicable Models	P45
ECU Terminal Arrangement Table	P48
■ MAZDA	
Table of Applicable Models	P50
ECU Terminal Arrangement Table	P52
■ SUBARU	
Table of Applicable Models	P54
ECU Terminal Arrangement Table	P56
■ SUZUKI	
Table of Applicable Models	P58
ECU Terminal Arrangement Table	P60
■ DAIHATSU	
Table of Applicable Models	P62
ECU Terminal Arrangement Table	P63

■ Introduction

“Safety precautions” are described in the Instruction Manual.

Please read them before starting installation work.

“Signal words and their meanings” are described in the Instruction Manual for this product. The “Electronic Control Unit” is abbreviated as “ECU” in this document.

CAUTION

- **Entrust an experienced professional with the installation work of this product.**

After completion of the installation, hand over this document, Instruction Manual, and Warranty to the customer (user)

- **Do not pull the harness of the vehicle and the harness of this product.**

This may cause wire damage or short circuits, resulting in damage to the product and vehicle.

- **When removing or connecting a connector, be sure to unlock the locked (claw) status beforehand.**

When the connector is provided with a securing bolt, loosen this bolt completely before pulling out the connector

Failure to do so may damage the connector.

- **Keep the harness of this product and vehicle harness away from high temperatures and moving parts. Also, Keep this harness away from water.**

Failure to do so may result in cut wires or short circuits that can lead to vehicle and product damage.

- **Do not route the harness of this product and the harness of the vehicle near a sharp-edges. Do not insert the harness between objects by applying pressure to it.**

Failure to do so may result in cut wires or short circuits that can lead to vehicle and product damage.

■ Precautions for Installation

● When installing this product, do not use any electro-taps

Using the electro-tap makes the electrical contact status unstable. This contact defect may cause a malfunction in the product and damage this product and the vehicle.

Be sure to use the attached splice and dedicated tools such as cutting pliers for electric work to install this product securely and properly.

● Insulate the metallic portion of the harness securely with electrical tape.

● Caulking the plug

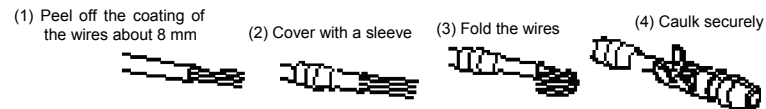

※Check if caulking has been performed securely by referring to the following figure

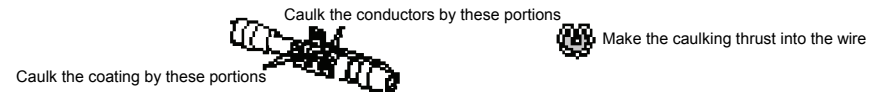

● Caulking the splice

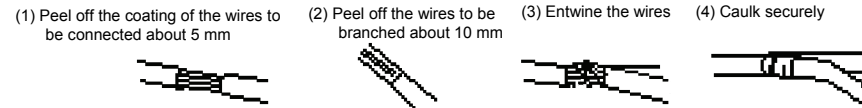

※Insulate the caulked portion securely with a vinyl tape

- The ground conductor of this product has two branches (black and brown). This has a very important significance to secure the voltage conversion accuracy. Connect the ground conductor by referring to the following figure. Installing the ground conductor in a different way from the connecting method specified by APEX-ERA will give damage to this product and the mounted car engine.

Correct Connecting Method for the Ground Conductor

Connect the ground conductor to two positions of the same line.
 Be sure to connect the brown wire to the ECU side.
 Allow a space of 1 cm or more between the connecting point of the black wire and the connecting point of the brown wire.

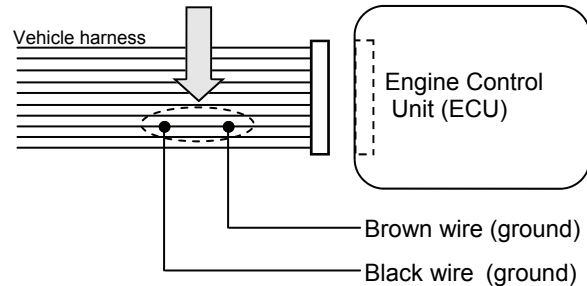

Wrong Connecting Method for the Ground Conductor

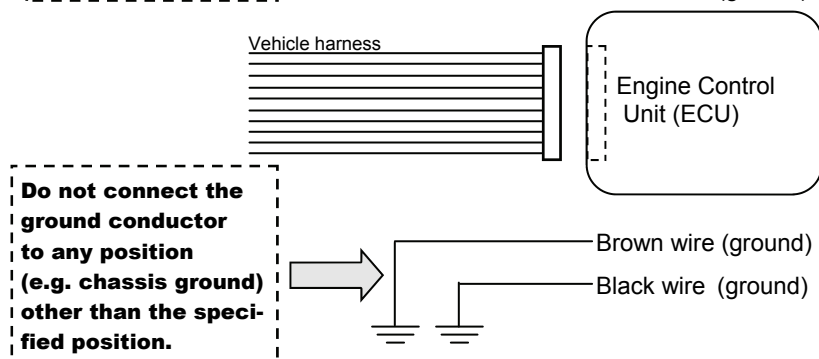
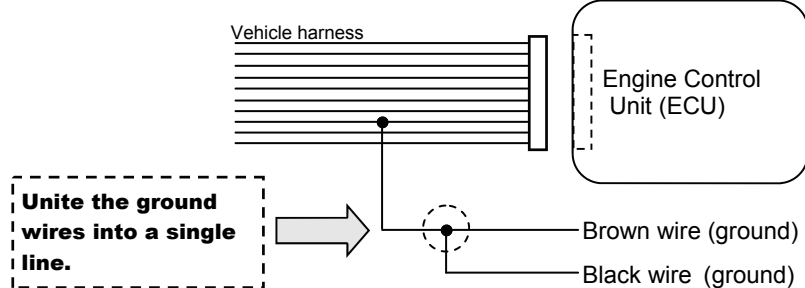

The above figure explains only the connection of the ground conductor. For the other signal lines, refer to page 6 and page 7. Be sure to wire the power cable, ground conductor and other signal lines to the positions specified by APEXERA.

■ Installation

● Connecting the SAFC II

1. Remove the negative (−) terminal of the battery

advice!

There is some setting data on car audio, car navigation, etc. that is backed up by the battery power supply. We recommend you to take a note of the data in case it is lost.



● Before starting the wiring work, remove the negative terminal of the battery.

Failure to do so may cause a short circuit and damage the wires. If the ECU connector is removed while the battery is connected, the engine warning lamp may light up continuously regardless of whether the SUPER AFC II is installed or not. At this time, you must ask the distributor of the car model to perform maintenance and inspection.

● We shall not take any responsibility for damage to the vehicle or related devices that may be caused by installation error.

2. Locate the Electronic Control Unit (hereafter referred to as ECU) of the vehicle by referring to the vehicle specific wiring diagram.
3. Connect the harness attached to the SUPER AFC II securely to the power cable of the vehicle harness, grounding wire, engine rpm signal wire, throttle signal wire, and knocking signal wire from to the ECU by referring to the vehicle specific wiring diagram. (Refer to page 8 and page 9.)

Connect the red wire to the power supply.
Connect the green wire to the engine rpm signal wire.
Connect the gray wire to the throttle signal wire.
Connect the black wire to the ground wire.
Connect brown wire to the ground wire.
Connect the purple wire to the knocking signal wire ···※

※ For models with a single knocking wire.

Connect the purple wire directly to the knocking signal wire.

※ For models with multiple knocking wires (knocking signal 1, knocking signal 2, ···)

Refer to page 11 without making any connection at this time.

■ Installation (cont.)

CAUTION

- **Be sure to connect the black wire and the brown wire of the harness attached to the SAFC II to the ground wire.**

Failure to do so may cause this product not to function properly, thereby causing damage to the product and the engine.

- **When locating each wire, take special care not to cause a short circuit.**

An electrical fire may be caused or electrical devices may be damaged as a result.

- **Securely install the splice without any loose contacts.**

Electric devices may be damaged as a result.

4. Cut the airflow signal wire or pressure signal wire of the vehicle harness and install a plug by referring to the vehicle specific wiring diagram.

Plug : ECU side

Plug receptacle : Airflow sensor or pressure sensor side

Vehicles equipped with the RB26DETT have 2 airflow signal wires.
Cut these 2 wires.

5. Connect the harness attached to the SAFC II to the plug installed in step 4

For Hot Wire/ Flap/Pressure sensor	Plug receptacle: White wire Plug: Yellow wire
For Karman	Plug receptacle: Orange wire Plug: Pink wire

6. Insulate the splice and unused plug with electrical tape.

7. Reconnect the negative (—) terminal of the battery.

■ Installation (cont.)

● Wire connecting method

※For vehicles using a hot wire/flap/pressure sensor

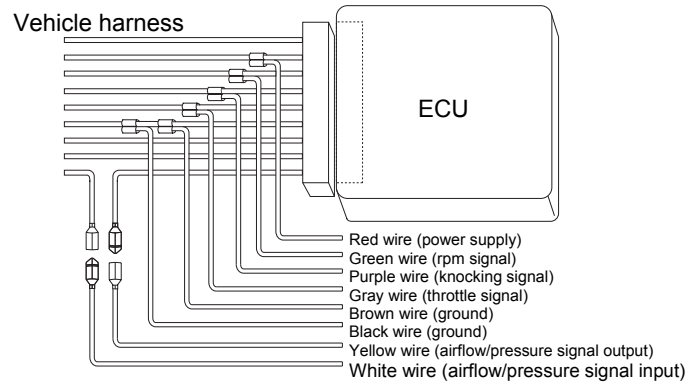

⚠ CAUTION

● Be sure to connect the brown wire to the ECU side.

Failure to do so may cause this product to function improperly, thereby causing damage to the product and the engine

※For vehicles equipped with the RB26DETT

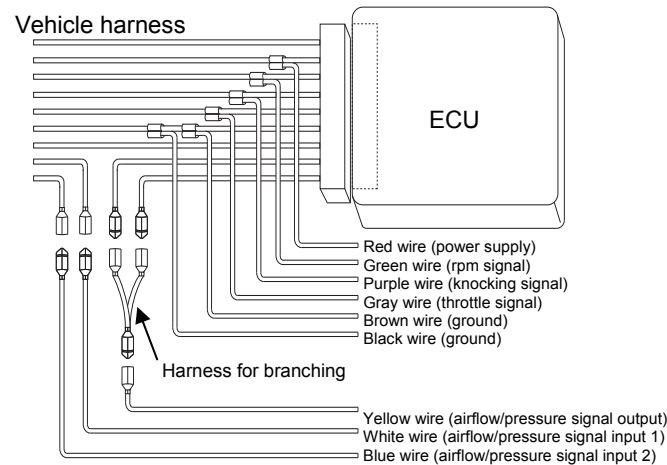

⚠ CAUTION

● Be sure to connect the brown wire to the ECU side from the black wire

Failure to do so may cause this product to function improperly, thereby causing damage to the product and the engine.

■ Installation (cont.)

※For vehicles using the Karman type frequency sensor

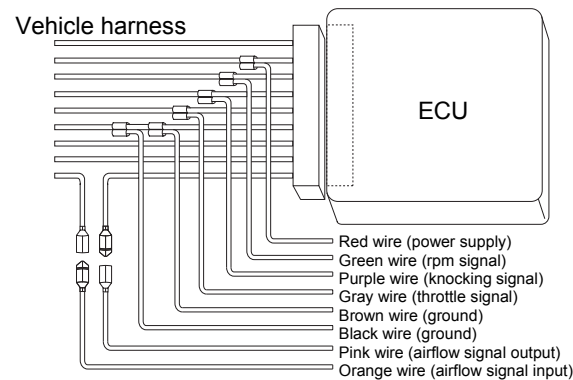

⚠ CAUTION

- **Be sure to connect the brown wire to the ECU side from the black wire.**
Failure to do so may cause this product to function improperly, thereby causing damage to the product and the engine.

⚠ WARNING

- **Mount the SAFC II so that it does not interfere with driving.**
Normal driving operations may be prevented, resulting in an accident.
- **Do not install the SAFC II in a high-temperature place or in a location where it may come in contact with water.**
An electric shock/fire may be caused. This may cause damage to the product and vehicle.
- **When routing the connecting harness of the SAFC II, route the harness away from moving parts.**
The connecting harness may be cut or short-circuited.
The SAFC II will be damaged, thereby causing damage to the vehicle and other electric parts.

● Check points after installation.

After installing the SUPER AFC II, check the following items once again

- Check if the harness attached to the SAFC II is securely connected
 - Check if the harness is not routed improperly
- Check if the SAFC II is securely mounted
- Check if the negative (−) terminal of the battery is securely connected

● Turn on the ignition switch. (Do not start the engine.)

Check the following contents after turning on the ignition switch

- Check if the characters are correctly displayed on the display screen of the SAFC II
If the display of this product is not correct, discontinue use of the product immediately and contact the distributor.

- Check for any abnormal noise or abnormal smell from the SAFC II and the vehicle.
If any abnormal noise or abnormal smell is sensed, discontinue use of this product immediately and contact the distributor.

● Initial setup

- If no abnormality is found with the ignition switch ON, perform initial setup for the SAFC II.

Perform sensor type and sensor number setting, number-of-cylinders setting, throttle sensor voltage check, throttle sensor type setting, throttle learning, and knocking signal correction according to “Initial Setup” on page 13 in the separate Instruction Manual.

- When the engine is ready to start after initial setup, the installation work is completed.



CAUTION

● Do not start the engine under any circumstance before the initial setup is performed

If the engine is started before initial setup, the engine may be damaged. Set the corresponding items by referring to page 13 in the Chapter pertaining to “Initial Setup” in the separate Instruction Manual.



WARNING

● If the engine check lamp illuminates, you must contact a dealer for inspection. If the vehicle is driven at a high speed with the engine warning lamp ON, the engine may be damaged, leading to an unexpected accident. Do not drive the vehicle under these conditions.

■ Installation (cont.)

※For vehicles equipped with multiple knocking signal wires

Connect only the power wire, ground wire, engine rpm signal wire, and throttle signal wire and proceed to the following operations.

For connecting the knocking signal wire, perform this work separately according to the following procedure

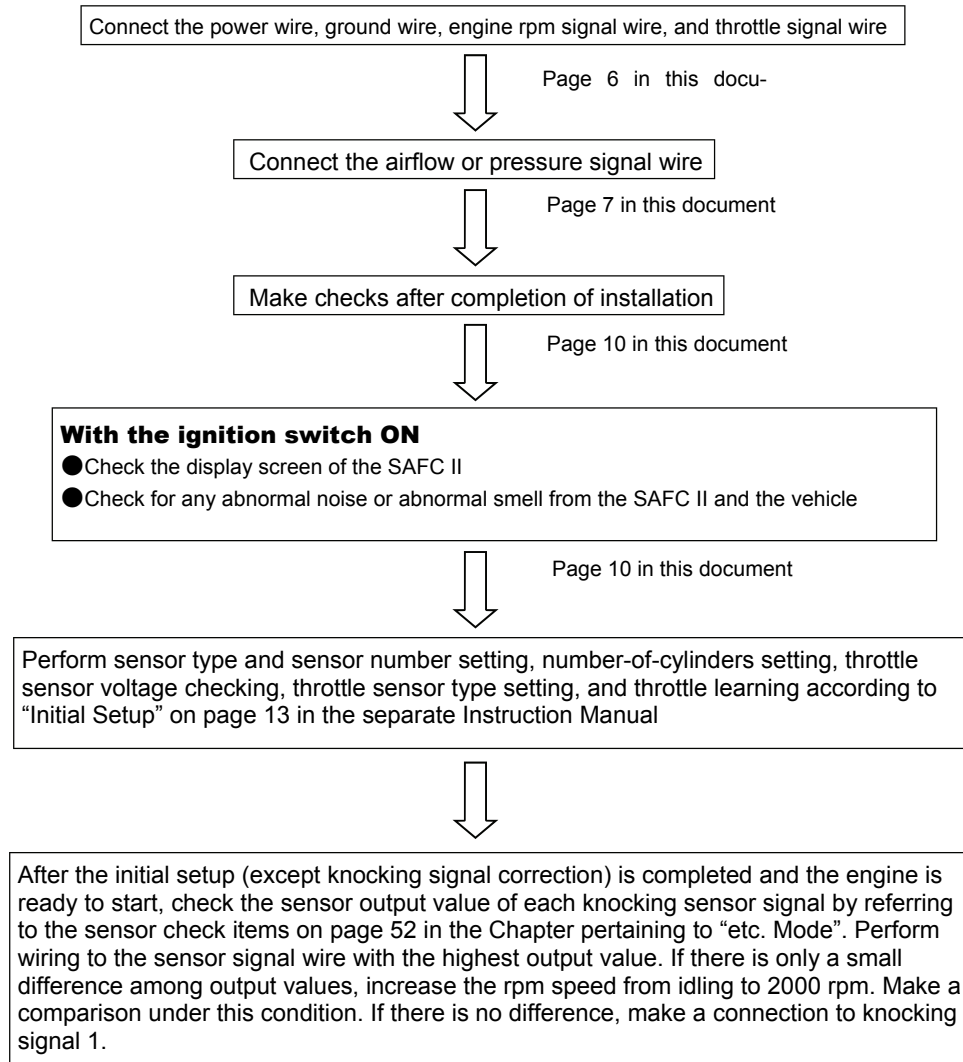

■ ECU Arrangement Diagram

● Perform installation by referring to the symbols in the corresponding columns of the tables of applicable models on and after page 14

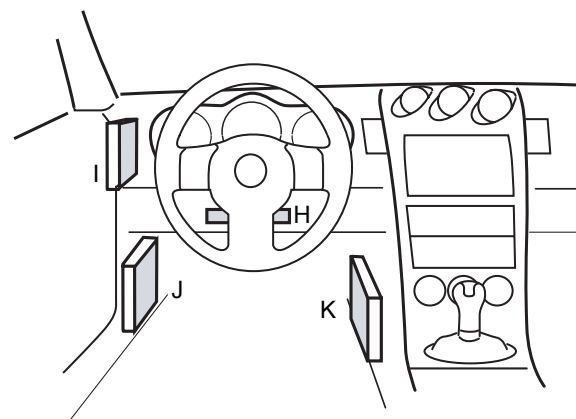
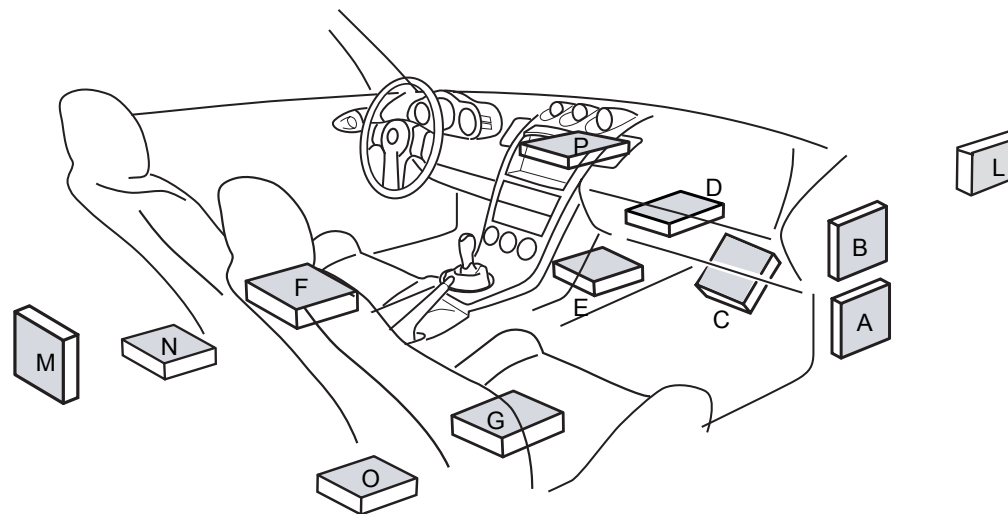

- A : Lower part of the passenger seat dash side
- B : Right side of the glove box
- C : Foot position of the passenger seat
- D : Inner part of the glove box
- E : Inner part of the center console
- F : Under the driver's seat
- G : Under the passenger seat
- H : Near the steering column
- I : Left side of the meter panel
- J : Lower part of the driver's seat dash side
- K : Left side of the center console
- L : Engine room
- M : Before the rear trunk
- N : Behind after the driver's seat
- O : Behind the passenger seat
- P : Upper inner part of the center console

■ How to Refer to the ECU Terminal Arrangement Diagram

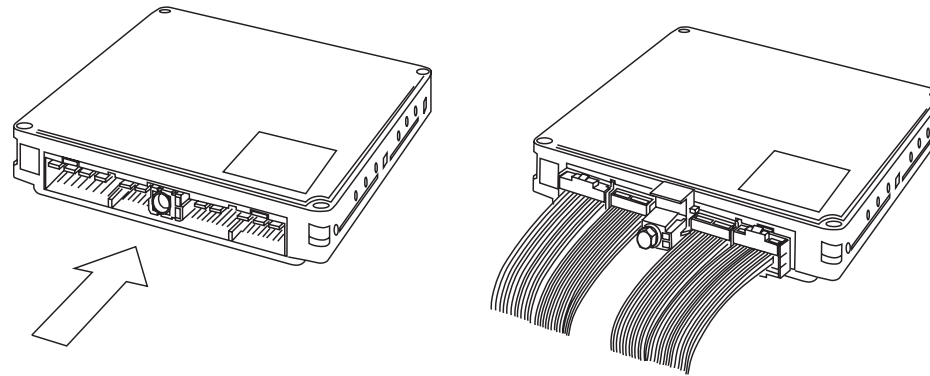

This ECU terminal arrangement diagram is viewed from the direction of the arrow.

The direction of the ECU varies depending upon the vehicle. Perform the installation work after confirming the connector shape and the number of pins.

WARNING

- **If any abnormal noise or abnormal smell is sensed during the installation work of this product, stop the work immediately and contact the distributor or your nearest APEXERA business office**
Continuing the installation under such conditions may cause an electric shock or fire causing damage to electric devices.

Table of Applicable Models (TOYOTA)

Explanation of sensor type indication

Example PR-3

Sensor type Sensor number

HW-Hot Wire
PR-Pressure

FL-Flap
KR-Karman

Car Name	Car Model	Engine Model	Manufacturing year	ECU Position	Remarks	Terminal Drawing	Sensor Type
CELCIOR	UCF2#	1UZ-FE	'97.7~'00.7	L		T10-e	HW-13
			'94.10~'97.6	D		T8-a	HW-12
	UCF1#		'92.9~'94.9				KR
			'89.10~'92.8		T5-f		
CROWN ROYAL	JZS173	1JZ-GE	'99.9~'01.7	L		T10-a	PR-16
CROWN ATHLETE	JZS171	1JZ-GTE	'99.9~'01.7	L		T10-b	HW-23
	JZS173	1JZ-GE				T10-a	PR-16
CROWN MAJESTA	UZS141	1UZ-FE	'91.10~'95.7	D		T7-b	KR
CROWN ESTATE	JZS171W	1JZ-GTE	'99.9~'01.7	L		T10-b	HW-23
	JZS173W	1JZ-GE				T10-a	PR-16
CROWN	JZS14#	2JZ-GE	'91.10~'95.7	D		T8-b	PR-3
ARISTO	JZS161	2JZ-GTE	'97.8~※	L		T10-c	HW-13
	JZS160	2JZ-GE	'97.8~'00.6				
	JZS147	2JZ-GTE	'91.10~'97.7	C		T7-c	PR-1
		2JZ-GE			PR-3		
UZS143	1UZ-FE	'92.10~'97.7		T7-b	KR		
SOARER	UZZ40	3UZ-FE	'01.4~※	L		T11-b	HW-25
	JZZ30	1JZ-GTE	'96.8~'01.3	C		T8-d	HW-12
			'91.5~'96.7			T8-c	PR-1
	JZZ31	2JZ-GE	'94.1~'96.7			T8-b	PR-3
	UZZ31	1UZ-FE	'94.1~'95.4			T8-a	KR
			'91.5~'93.12		T7-a		
	MZ20	7M-GTE	'89.1~'91.4	D		T5-a	
			'86.1~'88.12			T2-b	
GZ20	1G-GTE	'89.1~'91.4			T5-a	FL-1	
		'86.1~'88.12			T2-e		

Car Name	Car Model	Engine Model	Manufacturing year	ECU Position	Remarks	Terminal Drawing	Sensor Type	
SOARER	GZ20	1G-GE	'89.1~'91.4	D		T5-b	PR-3	
			'86.1~'88.12			T2-d		
SUPRA	JZA80	2JZ-GTE	'97.8~'02.8	C		T10-c	HW-13	
		2JZ-GE	'93.5~'97.7			T7-c	PR-1	
	JZA70		1JZ-GTE	'90.8~'93.4	D		T6-a	PR-1
	MA70	7M-GTE	'88.9~'90.7			T5-a	KR	
			'86.2~'88.8			T2-b		
			'88.8	Turbo A		T5-a	PR-1	
	GA70	1G-GTE	'88.9~'93.4				T2-e	FL-1
			'86.2~'88.8					
		1G-GE	'88.9~'93.4				T5-b	PR-3
			'86.2~'88.8				T2-d	
	MARK II	JZX110	1JZ-GTE	'00.10 ~'04.10	L		T10-b	HW-23
		JZX115	1JZ-GE				T10-a	PR-16
MARK II BLID	JZX110W	1JZ-GTE	'02.1~※	L		T10-b	HW-23	
	JZX115W	1JZ-GE				T10-a	PR-16	
MARK II QUALIS	MCV20W	1MZ-FE	'99.8~'02.1	E		T10-f	HW-13	
			'97.5~'99.7			T8-f		
	MCV25W MCV21W	2MZ-FE	'97.5~'02.1					
VEROSSA	JZX110	1JZ-GTE	'01.8~'04.4	L		T10-b	HW-23	
MARK II CRESTA CHASER	JZX100	1JZ-GTE	'96.9~'01.7	E	MARK II '96.9~'00.9	T8-d	HW-12	
	JZX90		'94.9~'96.8				T8-e	PR-1
			'92.10~'94.8				T8-c	
	JZX91	1JZ-GE	'92.10~'96.8			T6-a	PR-3	
		2JZ-GE	'94.9~'96.8			T8-d		
			'92.10~'94.8			T8-b		
	JZX81	1JZ-GTE	'90.8~'92.9		D		T6-a	PR-1
		1JZ-GE						PR-3
	GX81	1G-GTE	'88.8~'90.7				T5-a	FL-1
		1G-GE	'88.8~'92.9				T5-b	PR-3

Car Name	Car Model	Engine Model	Manufacturing year	ECU Position	Remarks	Terminal Drawing	Sensor Type	
MR2	SW20	3S-GTE	'93.10~'99.10	M		T5-c	PR-2	
			'91.12~'93.9				FL-2	
			'89.10~'91.11				T5-b	
		3S-GE	'97.12~'99.10			T9-b	HW-13	
			'93.10~'97.11			T6-b	PR-3	
			'91.12~'93.9			T5-c		
	AW11	4A-GZE	'86.8~'89.9			T2-a		FL-3
			4A-GE		'84.6~'89.9		T1-a	PR-3
		CELICA	ZZT230		1ZZ-FE	'99.9~※	L	
ZZT231	2ZZ-GE							
ST205	3S-GTE		'94.2~'99.8	E		T5-c	PR-2	
ST203 ST202	3S-GE		'93.10~'97.11			T6-b	PR-3	
			3S-FE		'96.6~'99.8	M/T		T4-f
	'95.8~'96.5				A/T	T5-g		
	'93.10~'95.7				M/T	T4-a		
	ST185		3S-GTE		'91.9~'93.9	A/T		T5-c
'89.10~'91.8						FL-2		
ST182	3S-GE		'89.10~'93.9			T5-b	T5-c	PR-3
ST165	3S-GTE		'85.8~'89.9			T2-a	FL-2	
ST162	3S-GE					T2-c		
CURREN	ST206		3S-GE		'94.1~'98.7	E		T6-b
	ST207 ST206	3S-FE	'96.6~'98.7		M/T		T4-f	
			'95.10~'96.5		A/T		T5-g	
				M/T	T4-a			
			With A/T TRC	T6-b				
			Without A/T TRC	T5-c				
			With TRC	T6-b				
			Without TRC	T5-c				
		'94.1~'95.9						

Car Name	Car Model	Engine Model	Manufacturing year	ECU Position	Remarks	Terminal Drawing	Sensor Type	
CARINA ED CORONA EXIV	ST203 ST202	3S-GE	'93.10~'98.12	E		T6-b	PR-3	
		3S-FE	'96.6~'98.12		M/T	T4-f		
			'95.8~'96.5		A/T	T5-g		
					M/T	T4-a		
					With A/T TRC	T6-b		
					Without A/T TRC	T5-c		
					With TRC	T6-b		
		'93.10~'95.7	Without TRC		T5-c			
CALDINA	ST246W	3S-GTE	'02.9~※	D		T12-a	PR-2	
	ZZT241W	1ZZ-FE				HW-24		
	ST215W	3S-GTE	'97.8~'02.8			T9-a	PR-2	
	ST215G ST210G	3S-FE				T5-d	PR-3	
	ST195G	3S-GE	'95.2~'97.7			T6-b		
	ST195G ST191G	3S-FE	'96.1~'97.7		M/T	T4-f		
					2WD A/T	T5-e		
					4WD A/T	T5-g		
					FF With TRC	T6-b		
					FF Without TRC	T5-c		
					4WD M/T	T4-a		
	ST190G	4S-FE	'92.11~'94.1		4WD A/T	T5-c		
					FF A/T	T6-c		
					4WD M/T	T4-a		
					4WD A/T	T5-c		
CAROLLA FX	AE101	4A-GE	'92.5~'95.4	E	M/T	T4-b		FL-4
		4A-FE			A/T	T5-b	PR-3	
					M/T	T4-b		
	AE92	4A-GE	'89.5~'92.4		A/T	T5-c		
					'87.5~'89.4			T4-b
								T1-a

Car Name	Car Model	Engine Model	Manufacturing year	ECU Position	Remarks	Terminal Drawing	Sensor Type	
CAROLLA SPRINTER	AE111	4A-GE	'97.4~'00.9	E		T5-b	PR-3	
		4A-FE	'95.5~'97.3			T4-b		
	AE110	5A-FE	'95.5~'00.9					
	AE101	4A-GE	'91.6~'95.4		M/T		FL-4	
		4A-FE			A/T	T5-b	PR-3	
	AE92	4A-GE	'89.5~'91.5		M/T	T4-b		
					'87.5~'89.4	A/T		T5-c
						T4-b		
		'87.5~'89.4		T1-a				
LEVIN TRUENO	AE111	4A-GE	'95.5~'00.9	E		T5-b	PR-3	
		4A-FE				T4-b		
	AE110	5A-FE						
	AE101	4A-GZE	'91.6~'95.4			T5-b	PR-1	
		4A-GE			M/T	T4-b	FL-4	
		4A-FE			A/T	T5-b	PR-3	
	AE92	4A-GZE	'89.5~'91.5		M/T	T4-b		
			'87.5~'89.4		A/T	T5-c		
		4A-GE	'89.5~'91.5			T5-b	PR-1	
			'87.5~'89.4			T2-a	FL-3	
	AE86	4A-GEU	'83.5~'87.4		A		T1-c	PR-3
						T4-a		
					T1-a			
CERES MARINO	AE101	4A-GE	'92.5~'95.4	E	M/T	T4-b	FL-4	
					A/T	T5-b		
		4A-FE			M/T	T4-b	PR-3	
					A/T	T5-c		
ALTEZZA	SXE10	3S-GE	'98.10~※	L	M/T	T9-c	HW-15	
					A/T	T10-d		
ALTEZZA GITA	JCE15W JCE10W	2JZ-GE	'01.7~※	L		T10-b	HW-24	
MR-S	ZZW30	1ZZ-FE	'99.10~※	D	Including Sequential M/T	T9-b	HW-24	
OPA	ZCT1#	1ZZ-FE	'00.8~'02.5	D		T9-b	HW-24	

Car Name	Car Model	Engine Model	Manufacturing year	ECU Position	Remarks	Terminal Drawing	Sensor Type
STARLET	EP91	4E-FTE	'96.1~'99.7	D	M/T	T4-d	PR-1
		A/T	T4-c				
		4E-FE	'96.1~'97.12			T3-b	PR-3
	EP82	4E-FTE	'89.12~'95.12	E	M/T	T3-a	PR-1
			'92.1~'95.12		A/T	T4-b	
			'89.12~'91.12		T3-a		
		4E-FE	'89.12~'95.12			T3-c	PR-3
EP71	2E-TE 2E-E	'86.1~'89.11			T1-b	PR-1	
RAV4	ZCA26W ZCA25W	1ZZ-FE	'00.5~※	D		T9-b	HW-24
	SXA1#G	3S-FE	'97.9~'00.4	E	M/T	T4-f	PR-3
		A/T			T5-g		
	SXA11W	3S-GE	'96.8~'00.4			T5-c	
	SXA10W						
	SXA11G	3S-FE	'95.4~'97.8		M/T	T4-a	
			A/T		T5-c		
	SXA10G		'94.5~'97.8		M/T	T4-a	
			A/T		T5-c		
VITZ	NCP13	1NZ-FE	'02.12~※	D		T12-a	HW-24
			'00.10~'02.11			T6-d	
	NCP10	2NZ-FE	'02.12~※			T12-a	
			'00.10~'02.11			T6-d	
	NCP15		'02.12~※			T12-a	
			'00.10~'02.11			T6-d	
FANCARGO	NCP25 NCP21	1NZ-FE	'99.8~※	P		T6-d	HW-24
	NCP20	2NZ-FE					
	NCP25 NCP21	1NZ-FE			With Steermatic	T9-d	
	NCP20	2NZ-FE					
ist	NCP61	1NZ-FE	'02.5~※	D		T12-a	HW-24
	NCP60	2NZ-FE					

Car Name	Car Model	Engine Model	Manufacturing year	ECU Position	Remarks	Terminal Drawing	Sensor Type
CAROLLA	ZZE12#	1ZZ-FE	'02.9~※	D		T12-a	HW-24
	NZE124 NZE121	1NZ-FE					
	ZZE12#	1ZZ-FE	'00.8~'02.8			T9-b	
	NZE124 NZE121	1NZ-FE				T6-d	
CAROLLA FIELDER	ZZE123G	2ZZ-GE	'02.9~※	D		T10-g	HW-24
	ZZE122G	1ZZ-FE			M/T	T9-b	
	NZE124G NZE121G	1NZ-FE			A/T	T12-a	
	ZZE123G	2ZZ-GE	'00.8~'02.8			T10-g	
	ZZE122G	1ZZ-FE				T9-b	
	NZE124G NZE121G	1NZ-FE				T6-d	
CAROLLA RUNX ALEX	ZZE123	2ZZ-GE	'02.9~※	D		T10-g	HW-24
	ZZE124 ZZE122	1ZZ-FE				T12-a	
	NZE124 NZE121	1NZ-FE					
	ZZE123	2ZZ-GE	'01.1~'02.8			T10-g	
	NZE124 NZE121	1NZ-FE				T6-d	
CAROLLA SPACIO	ZZE124N	1ZZ-FE	'01.7~※	D		T9-b	HW-24
	ZZE122N		'01.5~※				
	NZE121N	1NZ-FE				T6-d	
WILL VS	ZZE128	2ZZ-GE	'01.4~※	D		T10-g	HW-24
	ZZE129 ZZE127	1ZZ-FE				T9-b	
WILL CYPHA	NCP75	1NZ-FE	'02.10~※	D		T12-a	HW-24
	NCP70	2NZ-FE					
ALLION	ZZT240	1ZZ-FE	'01.12~※	B		T12-a	HW-24
	NZT240	1NZ-FE					
WISH	ZNE1#G	1ZZ-FE	'03.1~※	D		T12-a	HW-24

Car Name	Car Model	Engine Model	Manufacturing year	ECU Position	Remarks	Terminal Drawing	Sensor Type
PLATZ	NCP12	1NZ-FE	'02.8~※	E		T12-a	HW-24
	NCP16	2NZ-FE					
	SCP11	1SZ-FE					
	NCP12	1NZ-FE	'99.8~'02.7			T6-d	
	NCP16	2NZ-FE					
	SCP11	1SZ-FE					
bB	NCP30	2NZ-FE	'02.8~※	D		T12-a	HW-24
	NCP35 NCP31	1NZ-FE					
	NCP34		'02.8~'03.3				
	NCP30	2NZ-FE	'00.2~'02.7			T6-d	
	NCP35 NCP31	1NZ-FE					
	NCP34				'01.6~'02.7		
WINDOM	MCV30	1MZ-FE	'01.8~※	B		T11-a	HW-13
ESTIMA	MCR#0W	1MZ-FE	'00.1~※	D		T10-f	HW-15
ALPHARD	MNH1#W	1MZ-FE	'02.5~※	D		T10-f	HW-15
VOLTZ	ZZE137	2ZZ-GE	'02.8~※	D		T12-a	HW-24
	ZZE138 ZZE136	1ZZ-FE					
SIENTA	NCP81G	1NZ-FE	'03.9~※	B		T11-c	HW-24
PASSO	KGC10	1KR-FE	'04.6~※	D		T13-a	PR-20
PORTE	NNP1#	1NZ-FE 2NZ-FE	'04.7~※	D		T12-a	HW-24

■ ECU Terminal Arrangement Table (TOYOTA)

<p>T1-a 10p 18p 14p</p> <p>rpm 1 Pressure signal rpm 2 Ground Throttle signal IG power ※Without knocking signal</p>	<p>T1-b 10p 18p 14p</p> <p>rpm 2 rpm 1 Pressure signal Ground Knocking signal IG power ※Without throttle signal</p>
<p>T1-c 10p 18p 14p</p> <p>rpm 1 Pressure signal rpm 2 Ground IG power ※Without knocking signal and throttle signal</p>	<p>T2-a 10p 18p 24p</p> <p>rpm 1 Airflow signal rpm 2 Ground Throttle signal Knocking signal IG power</p>
<p>T2-b 10p 18p 24p</p> <p>rpm 2 rpm 1 Airflow signal Ground Throttle signal Knocking signal 1 Knocking signal 2 IG power</p>	<p>T2-c 10p 18p 24p</p> <p>rpm 2 rpm 1 Airflow signal Ground Throttle signal IG power ※Without knocking signal</p>
<p>T2-d 10p 18p 24p</p> <p>rpm 1 rpm 2 Airflow signal Ground Throttle signal Pressure signal IG power ※Without knocking signal</p>	<p>T2-e 10p 18p 24p</p> <p>rpm 1 Airflow signal rpm 2 Ground Knocking signal 1 Knocking signal 2 IG power ※Without throttle signal</p>
<p>T3-a 26p 16p</p> <p>rpm 1 Pressure signal Ground Knocking signal rpm 2 IG power ※Without throttle signal</p>	<p>T3-b 26p 16p</p> <p>rpm 1 Pressure signal Ground Knocking signal Throttle signal rpm 2 IG power</p>

Ordinary connection : rpm 1
Multiple connection : rpm 2

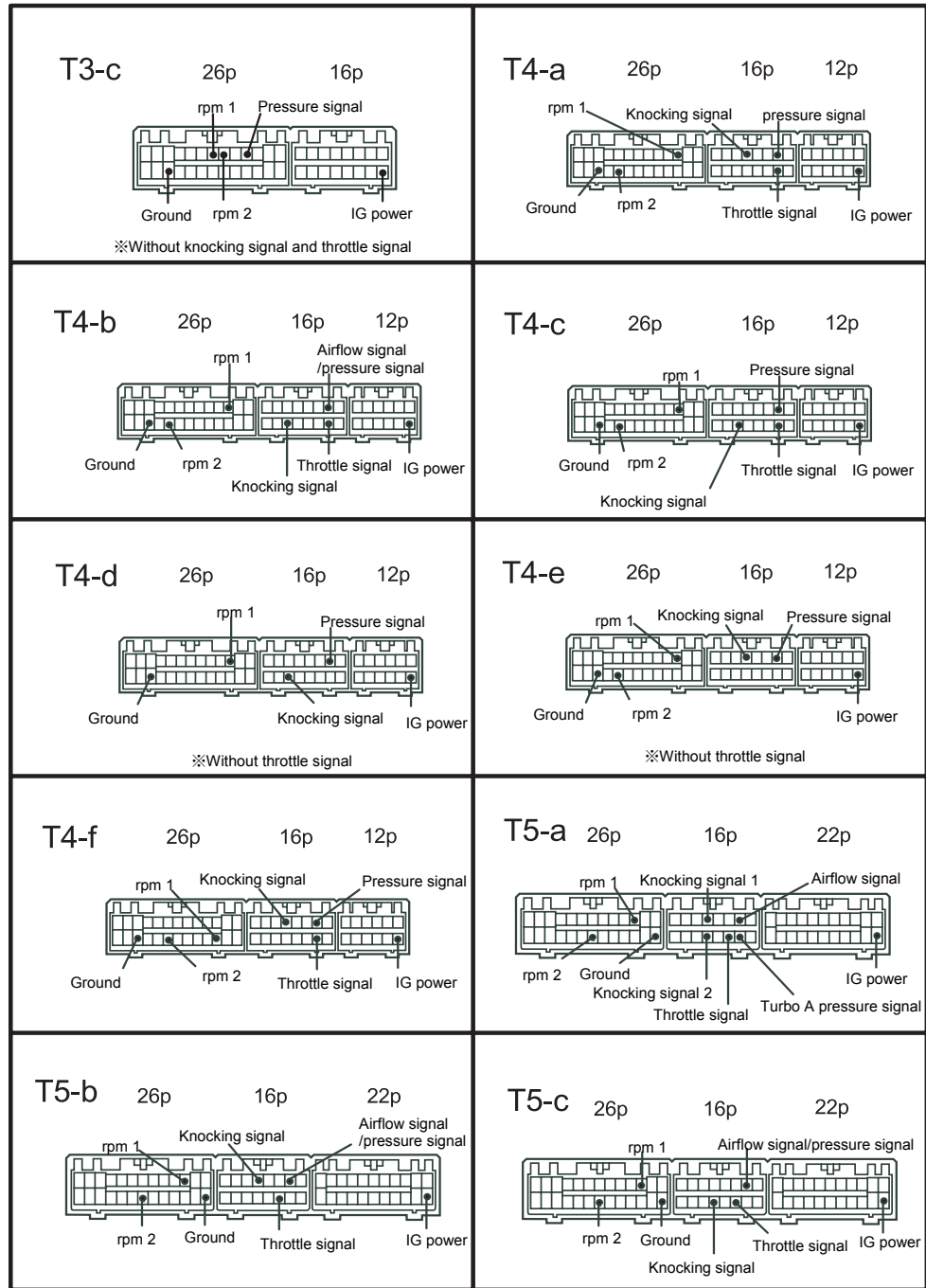

Ordinary connection : rpm 1
Multiple connection : rpm 2

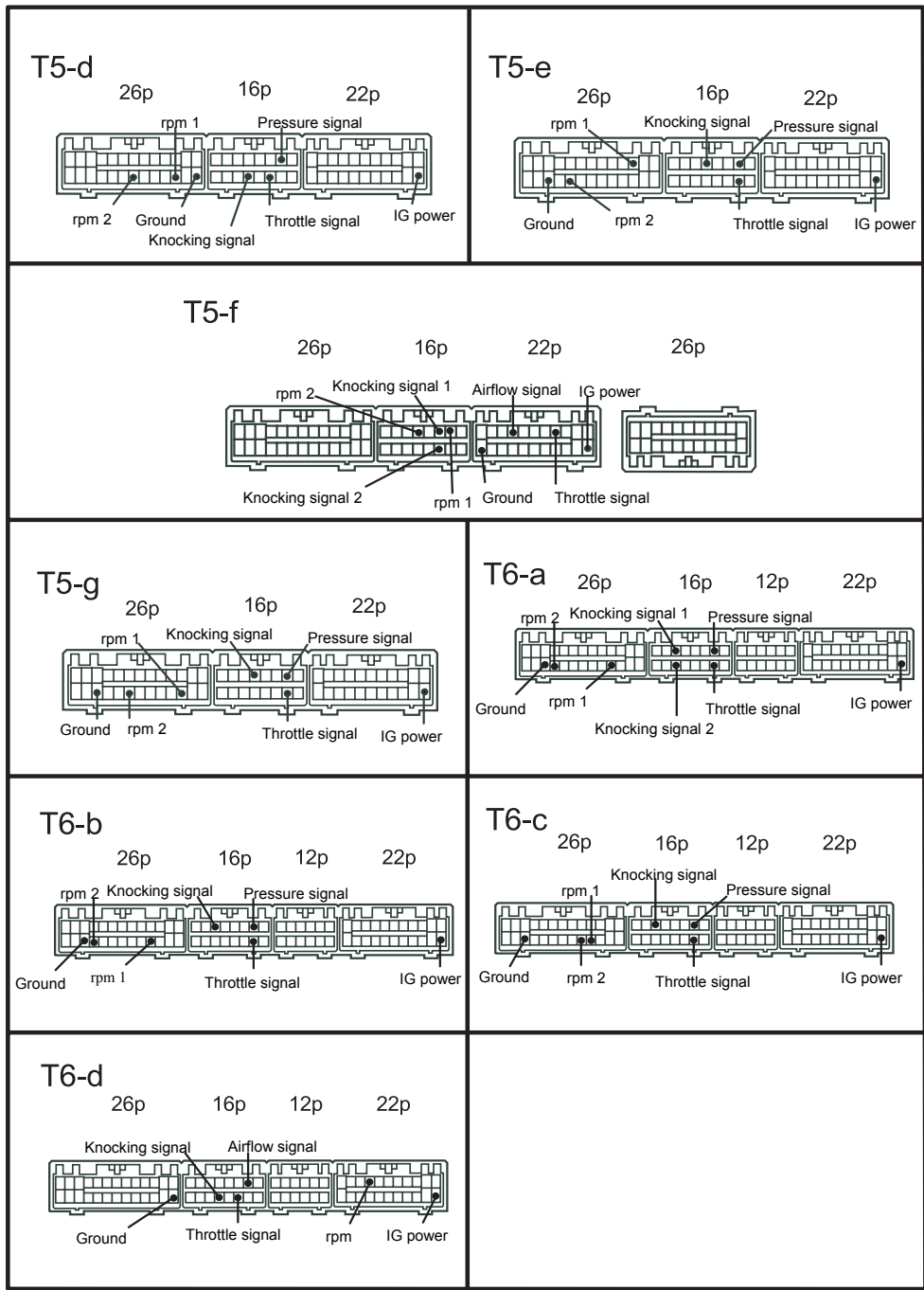

Ordinary connection : rpm1
 Multiple connection : rpm 2

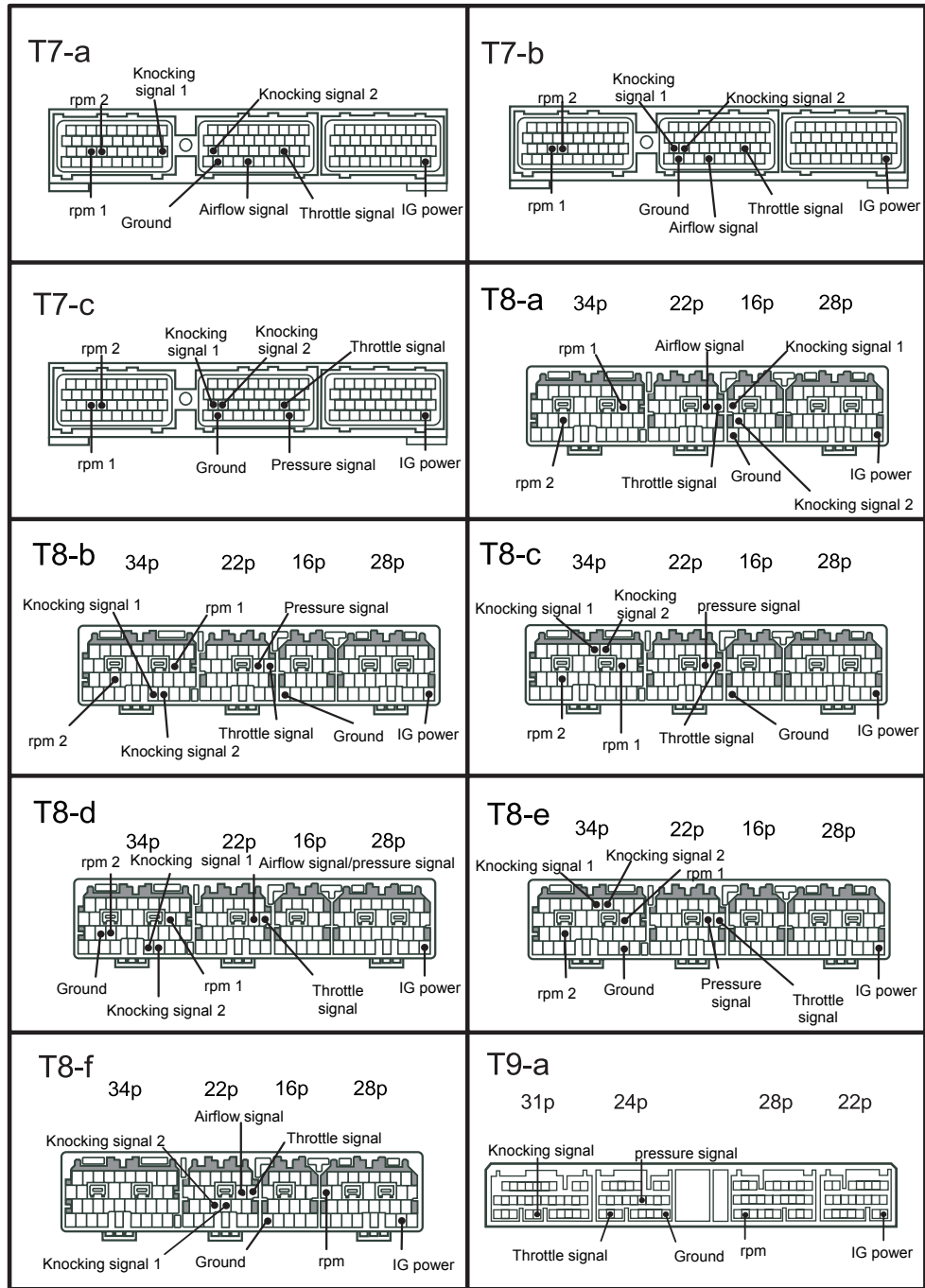

Ordinary connection : rpm 1
 Multiple connection : rpm 2

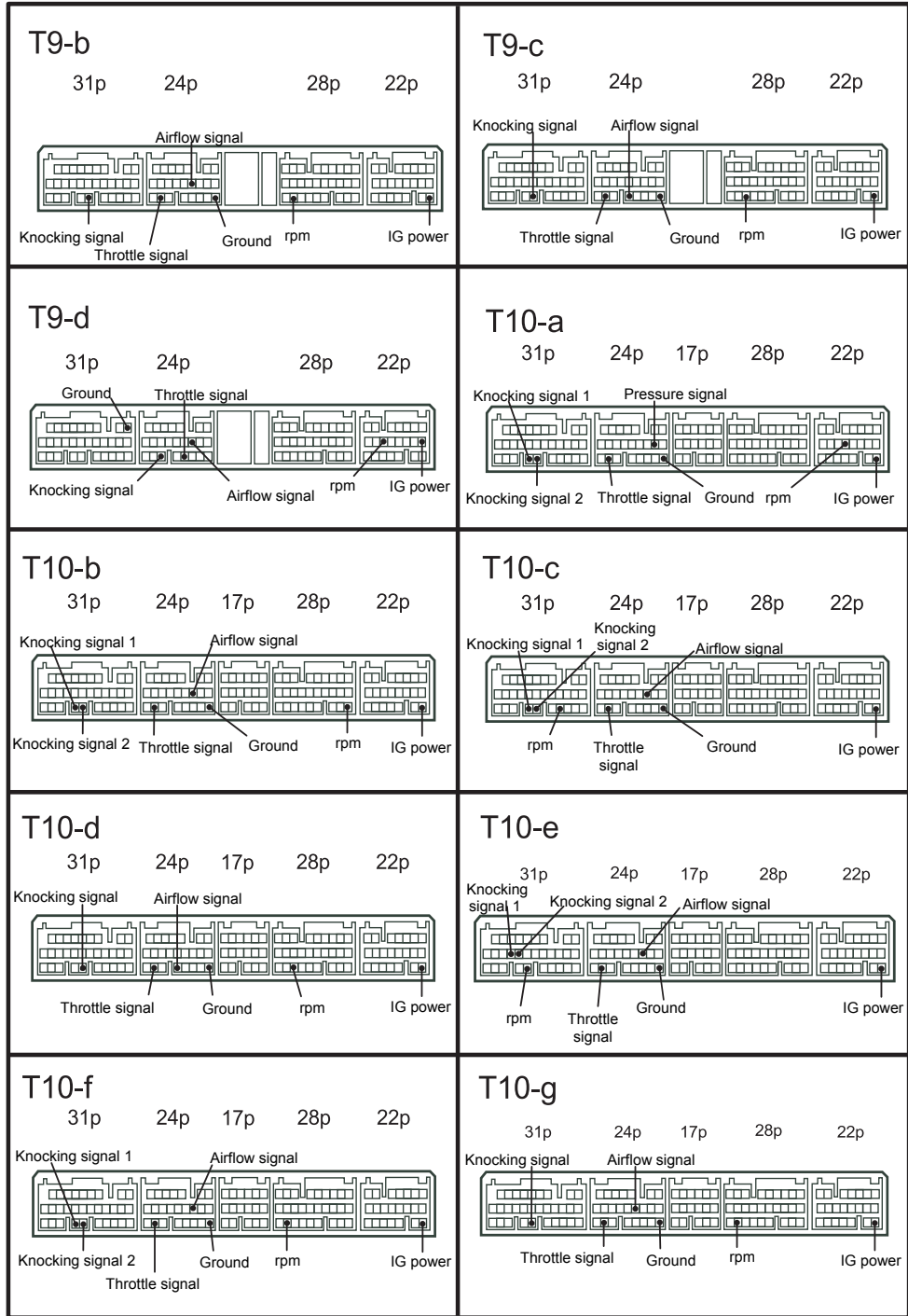

T11-a

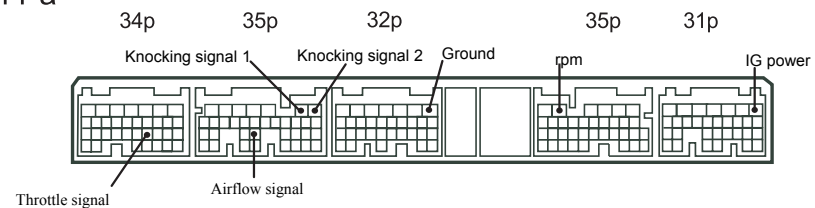

T11-b

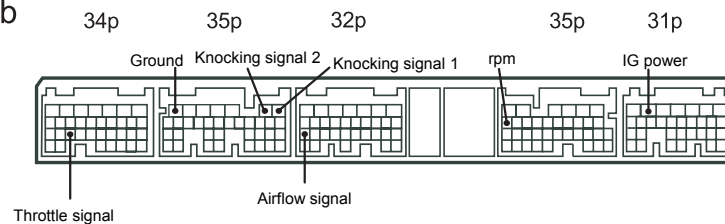

T11-c

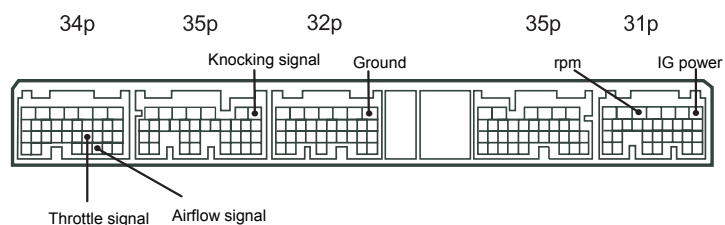

T12-a

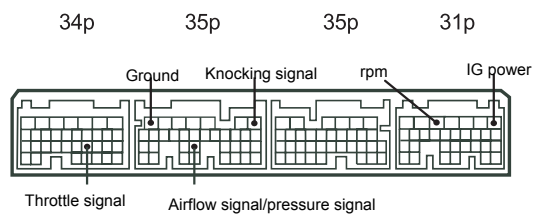

T13-a

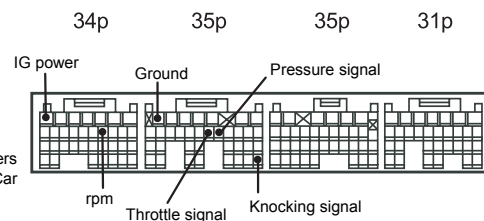

※Set the number of cylinders "1" at initial setting. [etc. → Car sel. → Cyl 1]

Table of Applicable Models (NISSAN)

Explanation of sensor type indication

Example PR-3

Sensor type Sensor number

HW-Hot Wire

PR-Pressure

FL-Flap

KR-Karman

Car Name	Car Model	Engine Model	Manufacturing year	ECU Position	Remarks	Terminal Drawing	Sensor Type
PRESIDENT	G50	VH45DE	'90.10 ~'02.12	A		N4-d	HW-1
INFINITY Q45	G50	VH45DE	'89.11~'97.9	A		N4-d	HW-1
CIMA	HF50	VQ30DET	'01.1~※	D		N8-c	HW-17
CIMA III	FGY33	VH41DE	'98.9~'00.12	A		N9-a	HW-1
	FHY33	VQ30DET				N5-a	HW-4
	FGY33	VH41DE	'96.6~'98.8			N6-a	HW-1
	FHY33	VQ30DET				N5-a	HW-4
CIMA II	FGY32	VH41DE	'91.8~'96.5	A		N4-d	HW-1
	FPY32	VG30DET	'93.9~'96.5			N4-e	HW-4
CIMA I	FPY31	VG30DET VG30DE	'89.8~'91.7	A		N4-i	HW-4
			'88.1~'89.7			N2-a	
FAIRLADY Z	Z33	VQ35DE	'02.7~※	D	Except Roadster/35th Anniversary Model / TypeE	N10-d	HW-26
	Z32	VG30DETT VG30DE	'89.7~'00.8	C			N4-a
LEOPARD	Y33	VQ25DE	'97.10~'99.6	A		N5-a	HW-4
		VQ30DET VQ30DE	'96.3~'99.6				
	UF31	VG30DET VG30DE	'88.8~'92.5			N4-g	
	GF31	VG20DET				N2-a	
LEOPARD J FERIE	JGBY32	VH41DE	'92.6~'96.2	A		N4-d	HW-1
	JPY32	VG30DE				N4-h	HW-4
CEDRIC GLORIA	Y34	VQ30DET	'99.6~'04.10	D		N8-c	HW-18
	Y33		'95.6~'99.5	A		N5-a	HW-4
		VQ30DE				N4-h	
Y32	VG30DET VG30DE	'91.6~'95.5				N4-h	

Car Name	Car Model	Engine Model	Manufacturing year	ECU Position	Remarks	Terminal Drawing	Sensor Type
CEDRIC GLORIA	Y31	VG20DET VG20E	'89.6~'91.5	A		N4-f	HW-4
CEFIRO	A33	VQ20DE	'01.1~'03.2	E		N8-a	HW-17
			'98.12~'00.12			N8-b	
	A32	VQ30DE VQ25DE	'97.1~'98.11			N6-c	HW-4
					VQ20DE	M/T	
		VQ30DE VQ25DE VQ20DE	'94.8~'96.12		N6-c		
	A31	RB20DET	'88.9~'94.7	A		N4-j	
		RB25DE	'92.5~'94.7			N4-b	
RB20DE		'88.9~'94.7			N4-j		
CEFIRO WAGON	W#A32	VQ25DE VQ20DE	'97.1~'00.8	E		N6-c	HW-4
		VQ30DE	'97.1~'99.7				
LAUREL	C35	RB25DET RB25DE RB20DE	'97.6~'02.12	A		N6-b	HW-4
	C34	RB25DET	'94.1~'97.5			N4-d	
		RB25DE RB20DE	'93.1~'97.5				
C33	RB20DET RB20DE	'89.1~'92.12					
SKYLINE	V35	VQ35DE	'03.2~※	D		N10-d	HW-26
			'02.2~※			N8-c	
	R34	RB26DETT	'99.1~'02.8	A		N4-c	HW-3
		RB25DET	'98.5~'01.5			N6-b	HW-4
	R33	RB26DETT	'95.1~'98.12			N4-c	HW-3
		RB25DET RB25DE	'93.8~'98.4			N4-d	HW-4
	R32	RB26DETT	'89.8~'94.12			N4-c	HW-3
		RB25DE	'91.8~'93.7			N4-d	HW-4
		RB20DET RB20DE	'89.5~'93.7				

Car Name	Car Model	Engine Model	Manufacturing year	ECU Position	Remarks	Terminal Drawing	Sensor Type
SKYLINE	R31	RB20DET RB20E	'87.8~'89.4	A		N1-a	HW-4
STEGEA	NM35	VQ25DET	'01.10~※	D		N8-c	HW-18
	W#C34	RB25DET RB25DE	'96.8~'01.9	A		N6-b	HW-4
STEGEA AUTECH Ver.260RS	WGNC34	RB26DETT	'97.10~'01.9	A		N4-c	HW-3
BLUEBIRD SYLPHY	G10	QG18DE	'00.8~※	L	2WD	N8-e	HW-18
		QG15DE			4WD	N7-a	
BLUEBIRD	U14	SR20VE	'97.9~'00.7	E		N3-a	HW-14
		SR20DE	'96.1~'00.7				HW-6
		SR18DE	'96.1~'98.8		Except the Lean Burn		
	U13	SR20DET SR20DE SR18DE	'91.9~'95.12				
		U12	SR20DET SR20DE		'89.10~'91.8		
			CA18DET CA18DE		'87.9~'89.9		N4-a
SILVIA	S15	SR20DET	'99.1~'02.7	A		N3-a	HW-5
	S14		'96.6~'98.12			N4-a	
					'93.10~'96.5		N3-a
	PS13	SR20DET	'93.10~'98.12			N3-b	HW-6
		SR20DE	'91.1~'93.9			N3-a	
	S13	CA18DET CA18DE	'88.5~'90.12			N4-a	HW-7
180SX	RPS13	SR20DET SR20DE	'96.8~'98.12	A		N3-a	HW-6
		SR20DET	'91.1~'96.7			N3-b	
	RS13	CA18DET	'89.3~'90.12			N4-a	HW-7

Car Name	Car Model	Engine Model	Manufacturing year	ECU Position	Remarks	Terminal Drawing	Sensor Type
PULSER	N15	SR16VE	'97.9~'00.8	E	Except the N1 Specification	N3-a	HW-6
		SR18DE	'95.1~'00.8				HW-14
	N14	SR20DET	'90.8~'94.12				HW-5
		SR18DE					HW-6
PRIMERA	P12	QR20DE	'02.5~※	D		N10-c	HW-18
			'01.1~'02.4				N8-d
		SR20VE	'01.8~'03.6				
	P11	SR20DE	'95.9~'00.12	HW-6			
		SR18DE	'95.9~'98.8				
		P10	SR20DE		'90.2~'95.8		
	SR18DE		'92.9~'95.8				
	PRIMERA WAGON	W#P12	QR20DE	'02.5~※	D		N10-c
'01.1~'02.4				N8-d			
SR20VE			'01.8~'03.6				
W#P11		SR20DE	'97.9~'00.12	HW-6			
		SR18DE	'97.9~'99.3				
AVENIR	W11	SR20DET	'98.8~'00.4	E		N3-a	HW-5
		SR20DE					HW-6
	W10	SR20DET	'95.8~'98.7				HW-5
		SR18DE	'93.1~'98.7				HW-6
SUNNY	B14	SR18DE	'94.1~'98.9	E		N3-a	HW-6
	B13		'90.1~'93.12				
NX COUPE	B13	SR18DE	'90.1~'93.12	E		N3-a	HW-6
MARCH	K12	CR14DE	'02.3~※	L	Except the M/T	N10-b	PR-11
		CR12DE					
		CR10DE					
	K11	CG13DE	'92.1~'02.2	E	Including CGA3DE	N3-c	HW-9
CG10DE							

Car Name	Car Model	Engine Model	Manufacturing year	ECU Position	Remarks	Terminal Drawing	Sensor Type
CUBE	Z11	CR14DE	'02.10~※	L		N10-b	PR-11
	Z10	CG13DE	'98.2~'02.9	C	Including CGA3DE	N3-c	HW-9
TERRANO	YD21	VG30E	'89.10~'95.8	F		N3-a	HW-6
X-TRAIL	T30	QR20DE	'00.11~※	B		N8-d	HW-18
		SR20VET	'01.2~※				HW-19
WINGROAD	Y11	QR20DE	'01.10~※	E		N8-d	HW-18
ELGRAND	E51	VQ35DE	'02.5~※	L		N10-a	HW-18
	APE50 APWE50		'00.8~'02.5	E		N8-a	HW-1
	ALE50 ALWE50	VG33E	'97.5~'00.8			N4-a	HW-6
SERENA	TC24 TNA24	QR20DE	'01.12~※		E		N8-d
BASSARA	JHU30	VQ30DE	'01.8~'03.6	E		N8-a	HW-18
MOCO	MG21S	K6A	'02.4~※	L	NA	N11-b	PR-13
					T/C	N11-a	PR-8

ECU Terminal Arrangement Table (NISSAN)

<p>N1-a</p> <p>15p 12p 20p 16p</p> <p>rpm IG power Ground Knocking signal Airflow signal</p> <p>※Without throttle signal</p>	<p>N2-a 16p 12p 20p 16p</p> <p>Knocking signal 5 rpm Knocking signal 1 Ground Knocking signal 4 Knocking signal 6 Knocking signal 2 Knocking signal 3 IG power Airflow signal</p> <p>※Without throttle signal ※Knocking signal 2 to 6 : For FPY31 only</p>
<p>N3-a</p> <p>16p 14p 16p 18p</p> <p>rpm Airflow signal Ground Knocking signal Throttle signal IG power</p>	<p>N3-b</p> <p>16p 14p 16p 18p</p> <p>rpm Airflow signal Ground Knocking signal Throttle signal IG power</p>
<p>N3-c</p> <p>16p 14p 16p 18p</p> <p>rpm Airflow signal Ground Knocking signal (99/11~) Throttle signal IG power</p>	<p>N4-a</p> <p>16p 20p 20p 20p</p> <p>rpm Knocking signal Airflow signal IG power Ground Throttle signal</p>
<p>N4-b</p> <p>16p 20p 20p 20p</p> <p>rpm Knocking signal 1 Airflow signal Knocking signal 2 IG power Ground Throttle signal</p>	<p>N4-c</p> <p>16p 20p 20p 20p</p> <p>rpm Knocking signal 1 Knocking signal 2 Airflow signal 1 Airflow signal 2 Throttle signal IG power Ground</p>
<p>N4-d</p> <p>16p 20p 20p 20p</p> <p>rpm Knocking signal 2 Airflow signal Knocking signal 1 Throttle signal IG power Ground</p>	<p>N4-e</p> <p>16p 20p 20p 20p</p> <p>rpm Knocking signal Airflow signal Throttle signal IG power Ground</p>

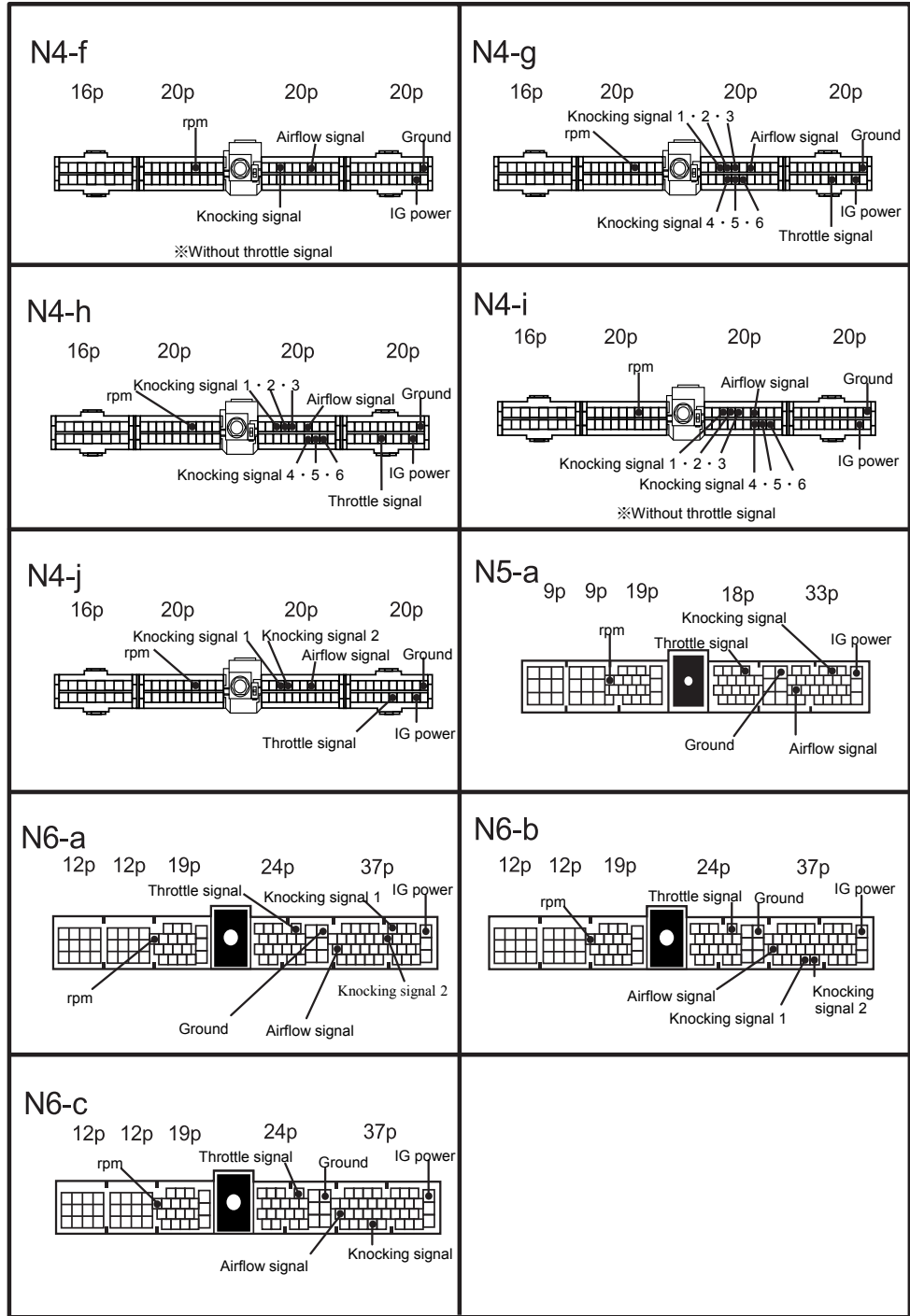

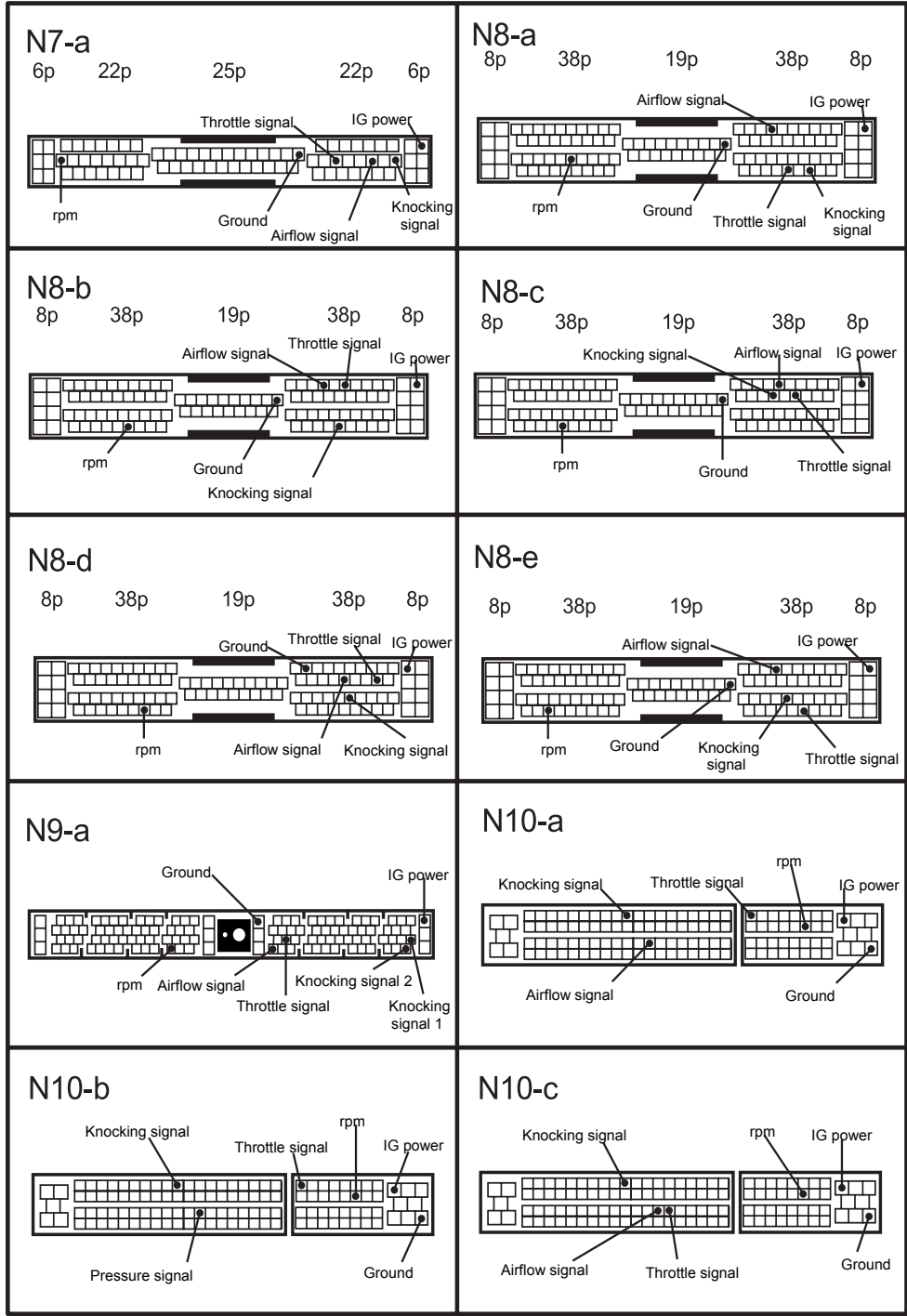

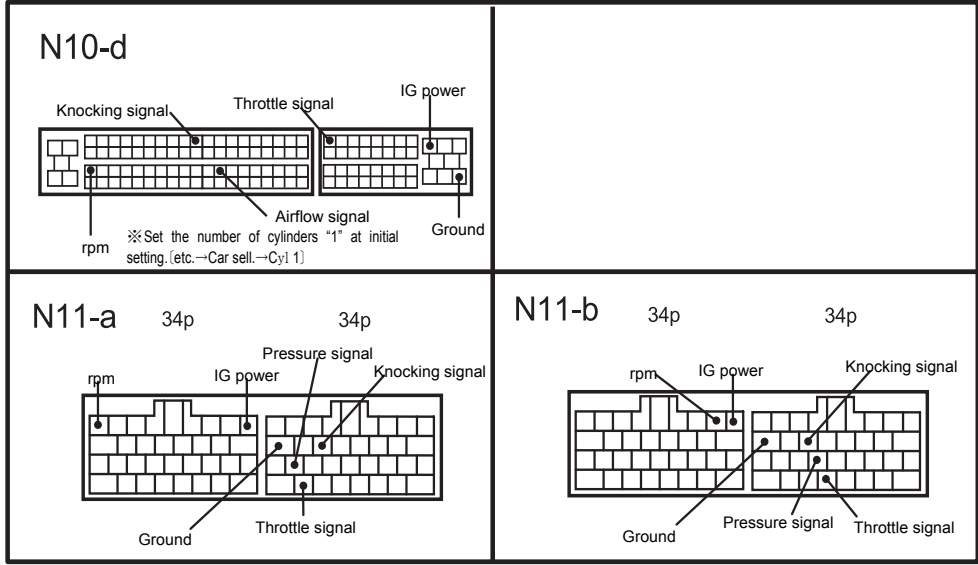

■ Table of Applicable Models (HONDA)

Explanation of sensor type indication

Example PR-3

Sensor type Sensor number

HW-Ho Wire

PR-Pressure

FL-Flap

KR-Karman

Car Name	Car Model	Engine Model	Manufacturing year	ECU Position	Remarks	Terminal Drawing	Sensor Type	
NSX	NA2	C32B	'97.2~※	N		H2-f	PR-6	
	NA1	C30A	'95.3~※					
			'90.9~'95.2			H2-a		
LEGEND	KA9	C35A	'96.2~'04.9	C		H2-a		
	KA8 KA7	C32A	'90.10~'96.1					
INSPIRE	UA5	J32A	'98.10~'03.5	E		H7-b		
	UA4	J25A						
	UA2	G25A	'95.2~'98.9	C		H2-c		
	UA1	G20A						
	CC2	G25A			'92.1~'95.1			H2-d
	CB5	G20A			'89.10~'91.12			H2-b
PRELUDE	BB8 BB6	H22A	'96.12~'00.9	C		H6-a		
	BB1		'91.9~'96.11		With TRC	H2-e		
	BB4				Without TRC	H3-b		
ACCORD EURO R	CL7	K20A	'02.12~※	E		H12-a		
	CL1	H22A	'00.6~'02.9			H8-a		
ACCORD	CL9	K24A	'02.10~※	E		H11-b		
	CL8 CL7	K20A						
	CL3	F20B	'00.6~'02.9		A/T	H7-c		
	CF3	F18B	'97.9~'00.5		M/T	H8-a		
						H7-a		
	CF4	F20B			A/T	H7-c		
	CD5	F22B	'93.9~'97.8		M/T	H8-a		
						H3-a		
CD6	H22A			H3-b				

Car Name	Car Model	Engine Model	Manufacturing year	ECU Position	Remarks	Terminal Drawing	Sensor Type
ACCORD WAGON	CM3 CM2	K24A	'02.11~※	E		H11-b	PR-6
	CH9	H23A	'99.1~'02.10		A/T	H7-c	
					M/T	H8-a	
	CL2	H23A	'00.6~'02.10		A/T	H7-c	
				M/T	H8-a		
	CF7 CF6	F23A	'97.10~'02.10			H7-a	
	CE1	F22B	'94.3~'97.9	C		H3-a	
CB9	F22A	'91.3~'94.2					
TORNEO EURO R	CL1	H22A	'00.6~'02.9	E		H8-a	
TORNEO	CL3	F20B	'00.6~'02.9	E	A/T	H7-c	
					M/T	H8-a	
	CF3	F18B	'97.9~'00.5		A/T	H7-c	
					M/T	H8-a	
S2000	AP1	F20C	'99.4~※	A		H8-b	
INTEGRA (Including the '98 specification)	DC5	K20A	'01.7~※	D		H9-a	
	DC2 DB8	B18C	'95.9~'01.6	A	M/T	H6-a	
					A/T	H2-e	
					M/T	H3-b	
	A/T	H2-e					
DA6	B16A	'89.4~'93.4	C		H1-a		
CIVIC	EP3	K20A	'01.12~※	D		H9-a	
	EU2 EU1	D15B	'00.9~※		Except the Lean Burn	H10-a	
	EU4 EU3	D17A					
	EK9	B16B	'00.8~'00.9	A		H8-b	
			'98.9~'00.7		H7-c		
'97.6~'98.8			H6-a				

Car Name	Car Model	Engine Model	Manufacturing year	ECU Position	Remarks	Terminal Drawing	Sensor Type
CIVIC	EK4	B16A	'98.9~'00.7	A		H7-a	PR-6
			'95.9~'98.8			H6-a	
	EK3	D15B	'98.9~'00.7			H7-a	
			'95.9~'98.8			H6-a	
	EG6	B16A	'91.9~'95.8			H3-b	
	EG4	D15B			Except the Carburetor	H3-a	
EF9	B16A	'89.9~'91.8		C	H1-a		
CR-X	EG2	B16A	'92.3~'95.10	A		H3-b	
	EG1	D15B		B		H3-a	
	EF8	B16A	'89.9~'92.2	C		H1-a	
CR-V	RD5 RD4	K20A	'01.9~※	D		H11-a	
	RD2	B20B	'97.10~'01.8	A		H7-c	
	RD1					H2-b	
ODYSSEY	RB2	K24A	'03.10~※	B		H11-c	PR-18
	RB1				Absolute	H11-c	
						H11-d	
	RA9 RA8	J30A	'00.8~'03.9	E		H7-c	PR-6
			'00.1~'03.9				
	RA7 RA6	F23A	'99.12~'03.9				
	RA5	J30A	'97.10~'99.11	C		H6-b	
RA4 RA3	F23A	'97.8~'99.11			H7-c		
RA2 RA1	F22B	'94.10~'97.7			H3-a		
S-MX	RH2 RH1	B20B	'99.9~'02.1	E		H7-c	
			'96.11~'99.8			H2-b	
STEP WAGON	RF4 RF3	K20A	'01.4~※	E		H11-a	
	RF2	B20B	'99.5~'01.3			H7-c	
			'96.5~'99.4			H2-b	
	RF1		'99.5~'01.3			H7-c	
			'96.5~'99.4			H2-b	

Car Name	Car Model	Engine Model	Manufacturing year	ECU Position	Remarks	Terminal Drawing	Sensor Type
ELYSION	RR2	K24	'04.5~ ※	E	2.4L	H11-c	PR-18
	RR1						
S-MX	RH2	B20B	'99.9~ '02.1	E		H7-c	PR-6
	RH1		'96.11~ '99.8			H2-b	
Z	PA1	E07Z	'98.10~ '02.1	N	T/C NA	H5-b H4-b	
LIFE	JB6 JB5	P07A	'03.9~ ※	B		H10-b	PR-18
	JB2 JB1	E07Z	'00.12~ '03.8	A		H5-c	PR-6
			'98.10~ '00.11			H5-d	
JA4	E07A	'97.4~ '98.9	G		H4-a		
LIFE DUNK	JB4 JB3	E07Z	'00.12~ ※	A		H5-c	
CAPA	GA6	D15B	'99.10~ '02.1	A		H5-a	
	GA4		'98.4~ '02.1				
STREAM	RN4 RN3	K20A	'00.10~ ※	D		H11-a	
	RN2 RN1	D17A					
FIT	GD4 GD3	L15A	'02.9~ ※	B		H10-a	
	GD2	L13A	'01.7~ ※				
	GD1		'01.6~ ※				
FIT ARIA	GD9 GD8	L15A	'02.12~ ※	B		H10-a	
	GD7 GD6	L13A					
THAT'S	JD2 JD1	E07Z	'02.2~ ※	D		H5-c	
MOBILIO	GB2 GB1	L15A	'01.12~ ※	B		H10-a	
MOBILIO SPIKE	GK2 GK1	L15A	'02.9~ ※	B		H10-a	

ECU Terminal Arrangement Table (HONDA)

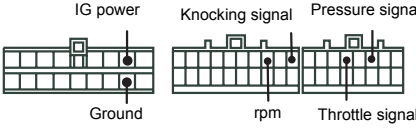
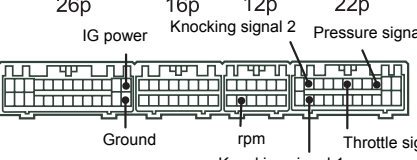
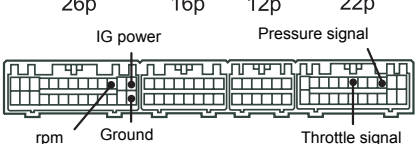
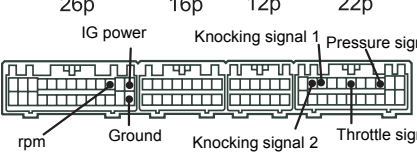
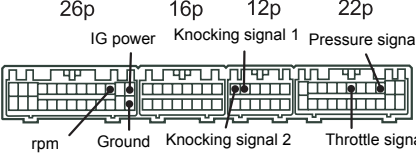
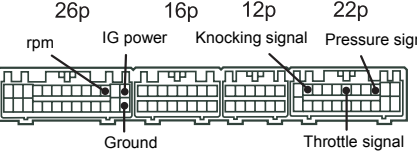
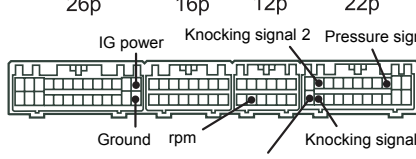
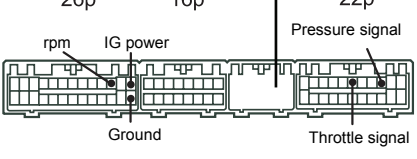
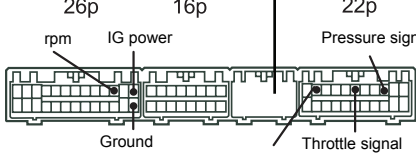
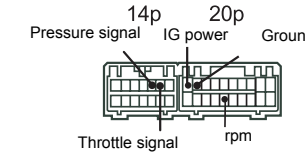
<p>H1-a 18p 20p 16p</p> <p>IG power Knocking signal Pressure signal</p>  <p>Ground rpm Throttle signal</p> <p>※SOHC E/g no knocking signal is available</p>	<p>H2-a</p> <p>26p 16p 12p 22p</p> <p>IG power Knocking signal 2 Pressure signal</p>  <p>Ground rpm Throttle signal Knocking signal 1</p>
<p>H2-b</p> <p>26p 16p 12p 22p</p> <p>IG power Pressure signal</p>  <p>rpm Ground Throttle signal</p> <p>※Without knocking signal</p>	<p>H2-c</p> <p>26p 16p 12p 22p</p> <p>IG power Knocking signal 1 Pressure signal</p>  <p>rpm Ground Knocking signal 2 Throttle signal</p>
<p>H2-d</p> <p>26p 16p 12p 22p</p> <p>IG power Knocking signal 1 Pressure signal</p>  <p>rpm Ground Knocking signal 2 Throttle signal</p>	<p>H2-e</p> <p>26p 16p 12p 22p</p> <p>rpm IG power Knocking signal Pressure signal</p>  <p>Ground Throttle signal</p>
<p>H2-f</p> <p>26p 16p 12p 22p</p> <p>IG power Knocking signal 2 Pressure signal</p>  <p>Ground rpm Knocking signal 1 Throttle signal</p>	<p>H3-a ※There might not be free space of connector</p> <p>26p 16p 22p</p> <p>rpm IG power Pressure signal</p>  <p>Ground Throttle signal</p> <p>※Without knocking signal</p>
<p>H3-b ※There might not be free space of connector</p> <p>26p 16p 22p</p> <p>rpm IG power Pressure signal</p>  <p>Ground Knocking signal Throttle signal</p>	<p>H4-a</p> <p>14p 20p</p> <p>Pressure signal IG power Ground</p>  <p>Throttle signal rpm</p> <p>※Without knocking signal</p>

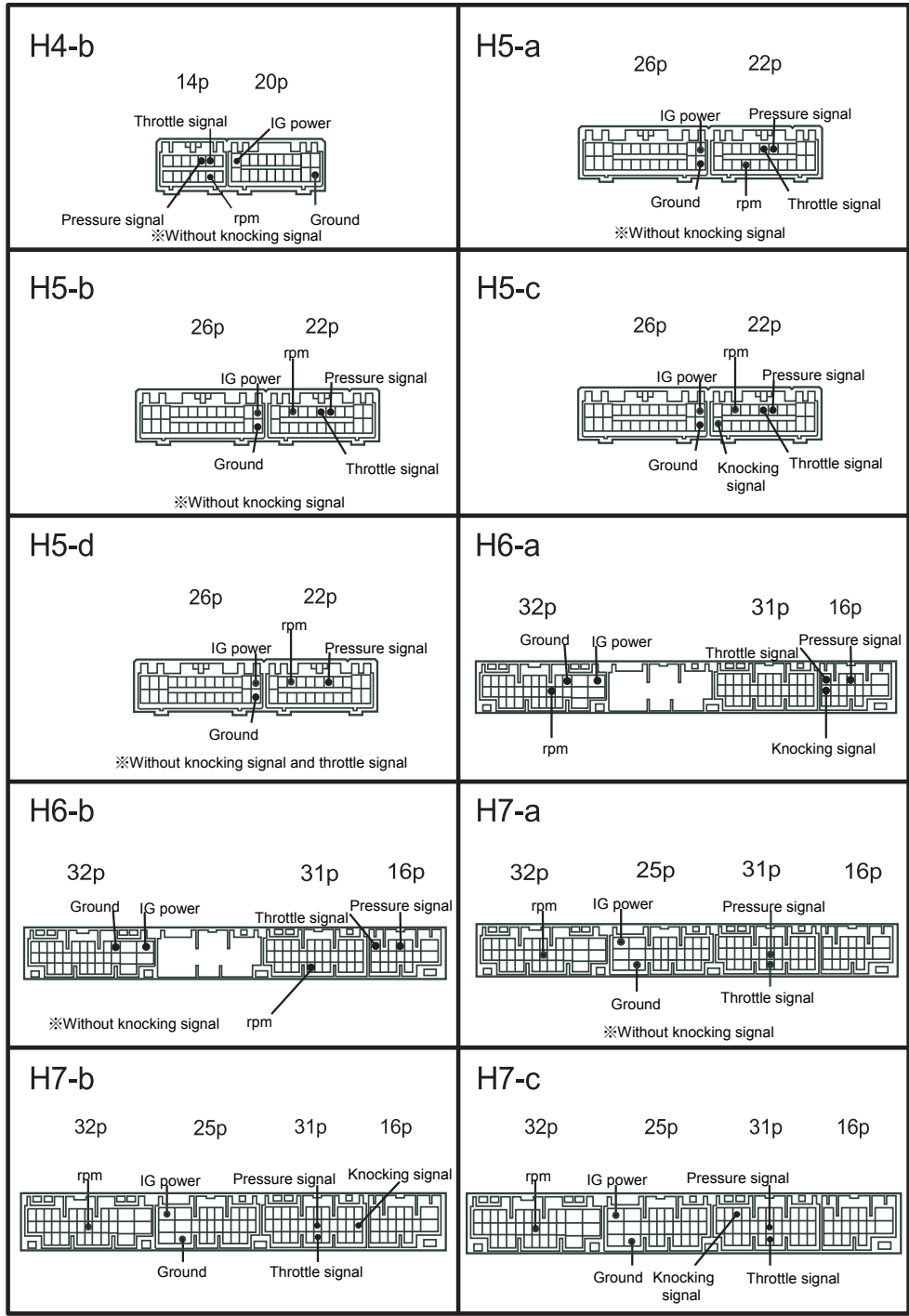

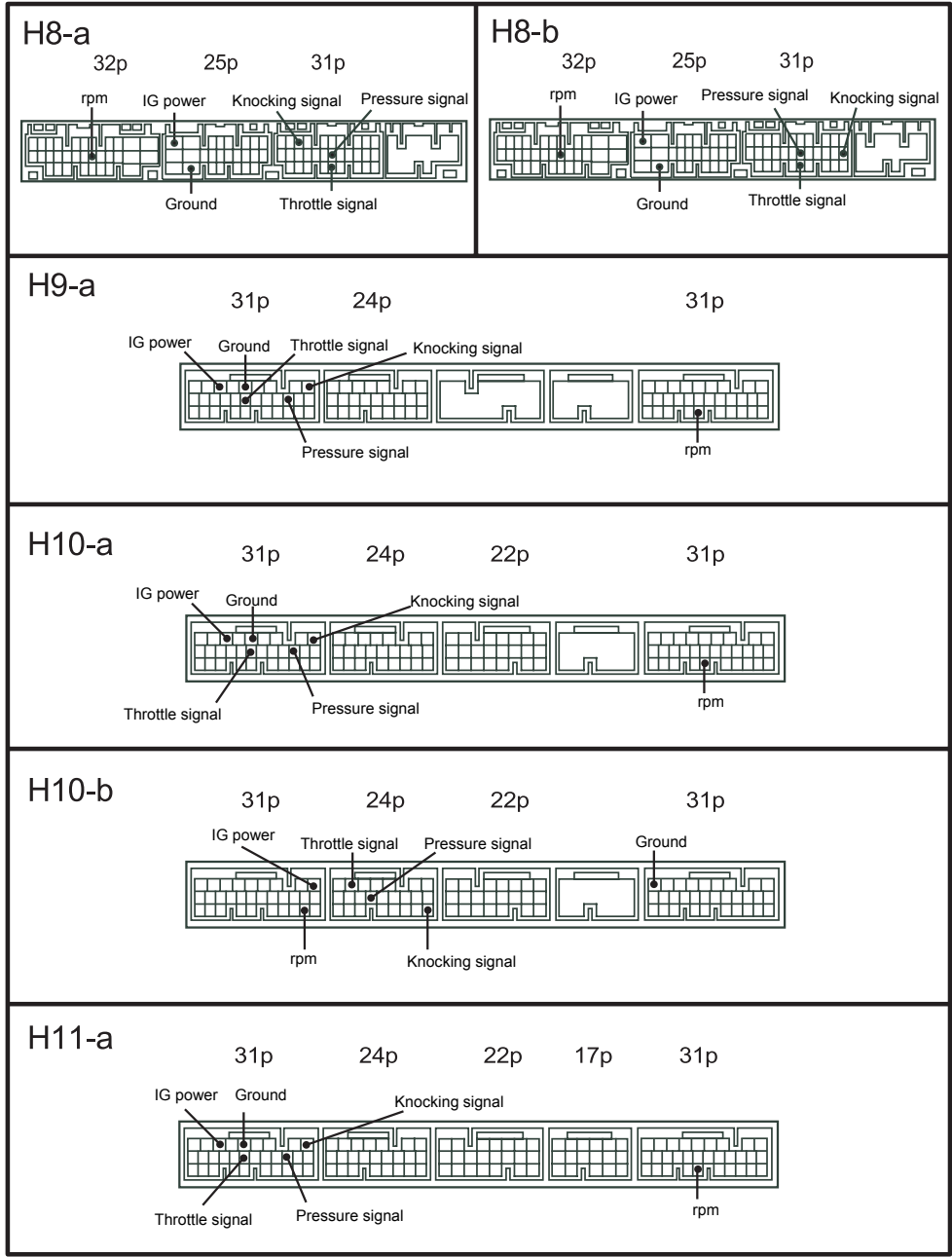

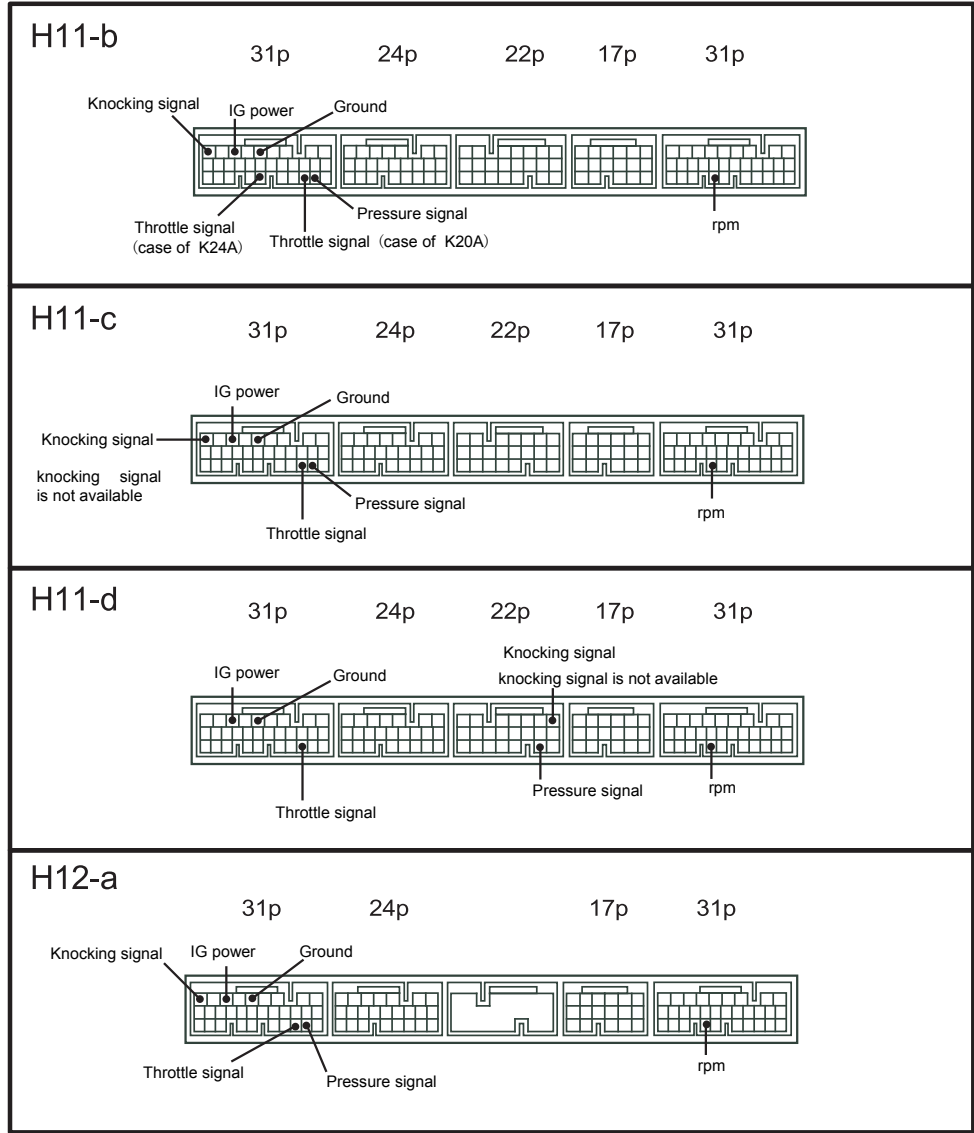

■ Table of Applicable Models (MITSUBISHI)

Explanation of sensor type indication

Example PR-3

Sensor type Sensor number

HW-Ho Wire
PR-Pressure

FL-Flap
KR-Karman

Car Name	Car Model	Engine Model	Manufacturing year	ECU Position	Remarks	Terminal Drawing	Sensor Type
DIAMANTE	F46A	6G72	'97.8~'02.9	E		M5-a	KR
			'96.1~'97.7		Without MIVEC	M6-a	
	'97.8~'02.9				M5-a		
	'96.1~'97.7		With MIVEC		M3-b	PR-5	
			Without MIVEC		M6-a	KR	
			With MIVEC	M3-b	PR-5		
	F17A	'90.5~'94.12	A	DOHC	M6-a M2-a	KR	
DIAMANTE WAGON	F36W	6G7	'97.10~'02.9	E		M6-b	KR
GTO	Z16A	6G72	'90.10~'00.7	E		M2-a	KR
FTO	DE3A	6A12	'97.2~'00.7	B	Without MIVEC A/T	M6-a	KR
			'94.10~'97.1		Without MIVEC M/T	M3-a	
			'96.2~'00.7		With MIVEC	M3-b	PR-5
						M3-a	KR
					M2-a		
		M3-a					
	DE2A	4G93	'94.10~'96.1			M3-a	
LEGNUM	EC5W	6A13	'96.8~'02.8	E	DOHC T/C	M3-a	KR
GALANT	EC5A	6A13	'96.8~'02.8	E	DOHC T/C	M3-a	KR
	E84A	6A12	'92.5~'96.7			M2-a	
	E39A	4G63	'87.10~'92.4	B	DOHC	M1-a	
ECLIPSE	D32A	4G63	'95.6~'99.12	E		M3-a	KR
	D27A		'89.11~'95.5			M1-a	
LIBERO	CD5W	4G93	'92.5~'00.5	B		M2-a	KR

Car Name	Car Model	Engine Model	Manufacturing year	ECU Position	Remarks	Terminal Drawing	Sensor Type
LANCER	CP9A	4G63	'98.1~'01.1	B	Including VI, TM	M3-a	KR
	CN9A		'96.8~'97.12				
	CE9A		'93.10~'96.7				
	CD9A		'92.10~'93.9				
	CK4A	4G92	'95.10~'00.5		MIVEC	M3-b	PR-5
	CM5A	4G93				M3-a	KR
	CD5A				'91.10~'95.9		
MIRAGE DINGO	CQ5A	4G93	'00.2~'02.8	E		M6-c	KR
	CQ2A	4G15	'00.1~'02.8				
			'98.12~'99.12			M3-a	
CQ1A	4G13	'00.1~'02.8		M6-d	PR-12		
MIRAGE	CM5A	4G93	'95.10~'00.5	B	T/C	M3-a	KR
	CJ4A	4G92			MIVEC	M3-b	PR-5
	CA4A		'91.10~'95.9			M2-a	
PAJERO	V75W V65W	6G74	'00.7~※	A		M6-a	KR
			'99.9~※		A/T	M6-c	
	V25W		'93.7~'99.1			M2-a	
	V23W	6G72	'92.6~'97.4			M1-a	
RVR	N64WG	4G64	'99.10~'02.8	C		M3-a	KR
	N74WG						
	N73WG	4G63	'97.11~'02.8	B	M/T		
	N71W N61W	4G93	'99.10~'02.8	C		M6-c	
			'97.11~'99.9	B		M3-a	
	N23W	4G63	'91.2~'97.10	B		M2-a	
ek WAGON	H81W	3G83	'02.9~※	B		M3-d	PR-12
			'01.10~'02.8			M4-a	
ek SPORTS	H81W	3G83	'02.9~※	B		M3-d	PR-12

Car Name	Car Model	Engine Model	Manufacturing year	ECU Position	Remarks	Terminal Drawing	Sensor Type	
CHARIOT GRANDIS	N96W N86W	6G72	'99.10~'03.4	C		M6-c	KR	
	N94W N84W	4G64	'00.5~'03.4			Without Cruise Control		M3-c
			'97.10~'00.4					
PAJERO io	H77W	4G94	'00.6~※	D		M5-a		
	H76W	4G93	'00.7~※		T/C			
	H6#W	4G94	'98.10~'00.6					
	H72W		'00.6					
LANCER EVOLUTION VIII MR	CT9A	4G63	'04.2~※	D		M5-a		
LANCER EVOLUTION VIII	CT9A	4G63	'03.1~'04.1	D		M5-a		
LANCER EVOLUTION VII	CT9A	4G63	'01.2~'02.3	D		M3-a		
			'02.2~'02.12		A/T	M6-a		
LANCER CEDIA	CS5A	4G93	'00.5~'03.1	D		M6-c		
LANCER CEDIA WAGON	CS5W	4G93	'00.11~'03.1	D		M6-c		
AIRTREK	CU4W	4G64	'01.6~※	E		M7-a		
	CU2W	4G63	'02.6~※		T/C	M6-a		
			'01.6~※					

■ ECU Terminal Arrangement Table (MITSUBISHI)

<p>M1-a</p> <p>10p 18p 24p rpm Knocking signal Airflow signal Ground IG power Throttle signal</p> <p>※In E39A, a knocking signal is available for TURBO only ※In V23W, no knocking signal is available</p>	<p>M2-a</p> <p>26p 16p 22p rpm Knocking signal IG power Ground Throttle signal Airflow signal/pressure signal</p> <p>※In CD5W, a knocking signal is available for DOHC only</p>
<p>M3-a</p> <p>26p 16p 12p 22p Knocking signal Airflow signal IG power Ground rpm Throttle signal</p> <p>※DE2A, no knocking signal is available</p>	<p>M3-b</p> <p>26p 16p 12p 22p Throttle signal Knocking signal IG power Ground rpm Pressure signal</p>
<p>M3-c</p> <p>26p 16p 12p 22p Knocking signal Airflow signal IG power Ground rpm Throttle signal</p>	<p>M3-d</p> <p>26p 16p 12p 22p Pressure signal Knocking signal IG power Ground rpm Throttle signal</p>
<p>M4-a</p> <p>26p 22p Pressure signal Throttle signal IG power Ground rpm</p> <p>※Without knocking signal</p>	<p>M5-a</p> <p>35p 28p 30p rpm Ground IG power Airflow signal Knocking signal Throttle signal</p>
<p>M6-a</p> <p>35p 26p 28p 30p IG power Ground rpm Throttle signal Airflow signal Knocking signal</p>	<p>M6-b</p> <p>35p 26p 28p 30p IG power Ground Throttle signal rpm Airflow signal</p> <p>※Without knocking signal</p>

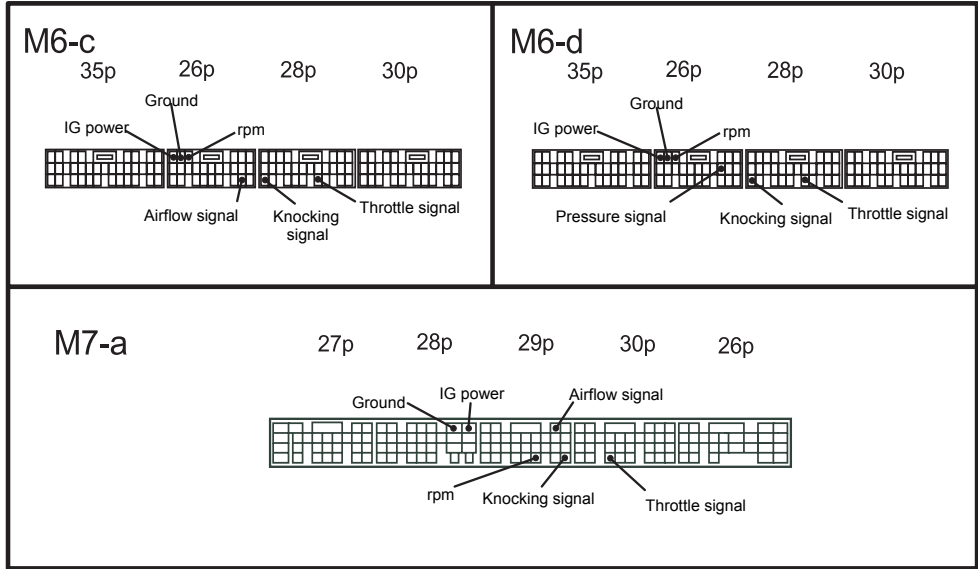

■ Table of Applicable Models (MAZDA)

Explanation of sensor type indication

Example PR-3

Sensor type Sensor number

HW-Hot Wire
PR-Pressure

FL-Flap
KR-Karman

Car Name	Car Model	Engine Model	Manufacturing year	ECU Position	Remarks	Terminal Drawing	Sensor Type
EUNOS COSMO	JC3S	13B-REW	'94.3~ '95.8	C B◎		Z3-a	FL-6
	JC3SE		'90.3~ '94.2				
	JCES	20B-REW	'94.3~ '95.8				
	JCESE		'90.3~ '94.2				
RX-7	FD3S	13B-REW	'95.12~ '02.8	A		Z4-a	PR-4
			'91.12~ '95.11			Z3-b	
	FC3S	13B	'88.9~ '91.11	C		Z2-a	FL-6
			'85.9~ '88.8			Z1-a	FL-5
ROADSTER	NA8C	BP-ZE	'95.8~ '97.12	C		Z6-a	HW-11
			'93.8~ '95.7			Z5-a	
	NA6CE	B6-ZE	'89.9~ '93.7		M/T	Z5-c	FL-8
			A/T	Z5-a			
FAMILIA	BJ5P	ZL-DE	'98.6~'03.6	D	4WD M/T	Z3-c	HW-22
					4WD A/T		
		ZL-VE	'98.9~'99.7		2WD	Z8-a	
					'98.6~'01.11	M/T	
			A/T				
	BJ3P	B3-ME	'98.6~'02.8				
BG8Z	BP-ZET	'89.8~'94.3	E		Z5-b	FL-7	
AZ-WAGON *1 This product amount is called even if the difference will be happen between stock price and S-AFC II	MD22S	K6A T/C	'00.12~※	L	M/T	Z7-a	EC-AT position
					A/T	Z7-b	
	MD11S	F6A T/C	'98.10~'00.11				
						Z7-a	
DEMIO	DY5W	ZY-VE	'02.8~※	L	※1	Z9-a	HW-22

Car Name	Car Model	Engine Model	Manufacturing year	ECU Position	Remarks	Terminal Drawing	Sensor Type
ATENZA SPORT	GGES	LF-DE	'02.5~※	C		Z10-a	HW-22
	GG3S	L3-VE	'02.10~※		M/T		
ATENZA SPORT WAGON	GYEW	LF-DE	'02.5~※	C		Z10-a	
	GY3W	L3-VE	'02.10~※		M/T		
ATENZA SEDAN	GGEP	LF-DE	'02.5~※	C		Z10-a	
	GG3P	L3-DE					
MPV	LW3W	L3-DE	'02.4~※	D		Z10-b	
VERISA	DC5W	ZY-VE	'04.6~※	L		Z9-a	

■ ECU Terminal Arrangement Table (MAZDA)

<p>Z1-a</p> <p>10p 18p 24p</p> <p>IG power Airflow signal Ground Throttle signal rpm Knocking signal</p>	<p>Z2-a</p> <p>26p 16p 22p</p> <p>Ground Throttle signal rpm Knocking signal Airflow signal IG power</p>
<p>Z3-a</p> <p>26p 16p 12p 22p</p> <p>Ground Knocking signal 2 Knocking signal 1 Throttle signal Knocking signal 3 Airflow signal IG power</p> <p>※Only the knocking signal 1 of 13B-REW ※The turn signal connects with EA-AT(Z3-AT)</p>	<p>Z3-AT</p> <p>20p 16p</p> <p>rpm</p> <p>EC-AT</p>
<p>Z3-b</p> <p>26p 16p 12p 22p</p> <p>Ground Throttle signal Pressure signal Knocking signal rpm IG power</p>	<p>Z3-c</p> <p>26p 16p 12p 22p</p> <p>Throttle signal Ground rpm Knocking signal Airflow signal IG power</p>
<p>Z4-a</p> <p>34p 22p 28p</p> <p>rpm Throttle signal Pressure signal IG power Knocking signal Ground</p>	<p>Z5-a</p> <p>26p 22p</p> <p>Airflow signal Ground Throttle signal rpm IG power</p> <p>※Without knocking signal</p>
<p>Z5-b</p> <p>26p 22p</p> <p>Airflow signal Ground rpm Throttle signal Knocking signal IG power</p>	<p>Z5-c</p> <p>26p 22p</p> <p>Airflow signal Ground rpm IG power</p> <p>※Without knocking signal and throttle signal</p>

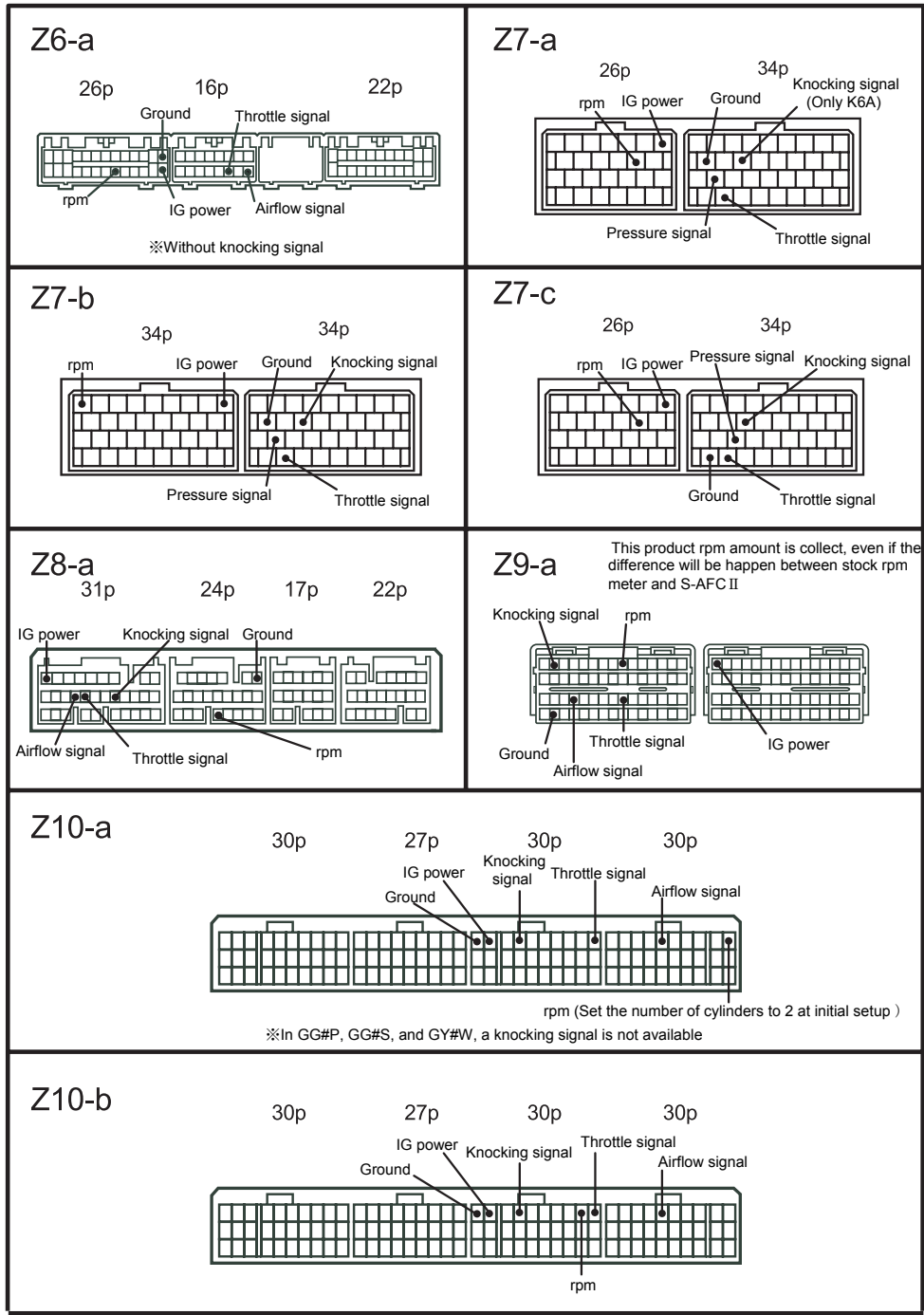

Table of Applicable Models (SUBARU)

Explanation of sensor type indication

Example PR-3

Sensor type Sensor number

HW-Ho Wire
PR-Pressure

FL-Flap
KR-Karman

Car Name	Car Model	Engine Model	Manufacturing year	ECU Position	Remarks	Terminal Drawing	Sensor Type	
LEGACY B4	BE9	EJ254	'01.5~'03.4	C		F5-b	HW-16	
	BE5	EJ208 EJ206				F8-c	HW-20	
		EJ204				F5-b	HW-16	
	BE5	EJ208	'98.12~'01.4			F4-a	HW-20	
		EJ204				HW-16		
LEGACY TOURING WAGON	BH5	EJ208 EJ206	'01.5~'03.4	C		F8-c	HW-20	
		EJ204				F5-b	HW-16	
	BH9 BHC	EJ254						
	BH5	EJ208 EJ206	'98.6~'01.4			F4-a	HW-20	
		EJ204				HW-16		
	BH9 BHC	EJ254						
LEGASY	BD5 BG5	EJ20R	'96.6~'98.5	C	M/T	F1-b	HW-1	
		EJ20H EJ20D				A/T	F3-a	HW-4
						T/C	F2-a	
			NA		F1-a			
	BC5 BF5	EJ20G	'89.2~'93.9		H		F2-b	HW-10
	BD9 BG9	EJ25D	'96.6~'98.5		C		F3-a	HW-4
			'94.10~'96.9				F1-a	
FORESTER	SG5	EJ205	'02.2~※	D	M/T	F8-a	HW-20	
					A/T	F8-b		
	SF5		EJ20G	'98.9~'02.1	C		F4-a	HW-1
				'97.2~'98.8			F1-b	HW-4

Car Name	Car Model	Engine Model	Manufacturing year	ECU Position	Remarks	Terminal Drawing	Sensor Type
IMPREZA	GDB GGB	EJ207	'00.10~※	C	Including Spec C	F8-a	HW-20
	GDA GGA	EJ205	'00.8~※				
	GD9 GG9	EJ204				F5-b	HW-16
	GG3 GG2	EJ152			M/T	F5-a	PR-8
	GC8 GF8	EJ207 EJ205			'98.9~'00.7		F4-a
		EJ20K	'96.9~'98.8			F1-b	HW-4
		EJ20G	'92.11~'96.8			F2-b	HW-10
	PLEO	RA2 RA1	EN07E		'01.10~※	B	SOHC NA
EN07Z			SOHC S/C				
EN07X			DOHC S/C				
EN07			'98.10~'01.9	SOHC S/C (Except the Mild Charge)	F2-d		
				DOHC S/C	F2-d		

■ ECU Terminal Arrangement Table (SUBARU)

<p>F1-a</p> <p>26p 16p 22p</p> <p>rpm Ground Throttle signal IG power</p> <p>Airflow signal Knocking signal</p>	<p>F1-b</p> <p>26p 16p 22p</p> <p>rpm Throttle signal Ground</p> <p>Airflow signal Knocking signal IG power</p>
<p>F2-a</p> <p>26p 16p 12p 22p</p> <p>rpm Throttle signal IG power</p> <p>Airflow signal Knocking signal</p> <p>Ground</p>	<p>F2-b</p> <p>26p 16p 12p 22p</p> <p>rpm Ground IG power</p> <p>Knocking signal Throttle signal Airflow signal</p>
<p>F2-c</p> <p>26p 16p 12p 22p</p> <p>rpm Ground Knocking signal</p> <p>IG power Throttle signal Pressure signal</p>	<p>F2-d</p> <p>26p 16p 12p 22p</p> <p>rpm Knocking signal Ground</p> <p>IG power Throttle signal Pressure signal</p>
<p>F3-a</p> <p>9p 9p 19p 18p 33p</p> <p>rpm Throttle signal Ground</p> <p>Airflow signal Knocking signal IG power</p>	<p>F4-a</p> <p>32p 32p 32p</p> <p>rpm Throttle signal Knocking signal</p> <p>Ground IG power Airflow signal</p>
<p>F5-a</p> <p>35p 26p 20p 28p</p> <p>rpm Pressure signal Ground</p> <p>Knocking signal Throttle signal IG power</p>	<p>F5-b</p> <p>35p 26p 20p 28p</p> <p>rpm Airflow signal</p> <p>Ground Knocking signal Throttle signal IG power</p>

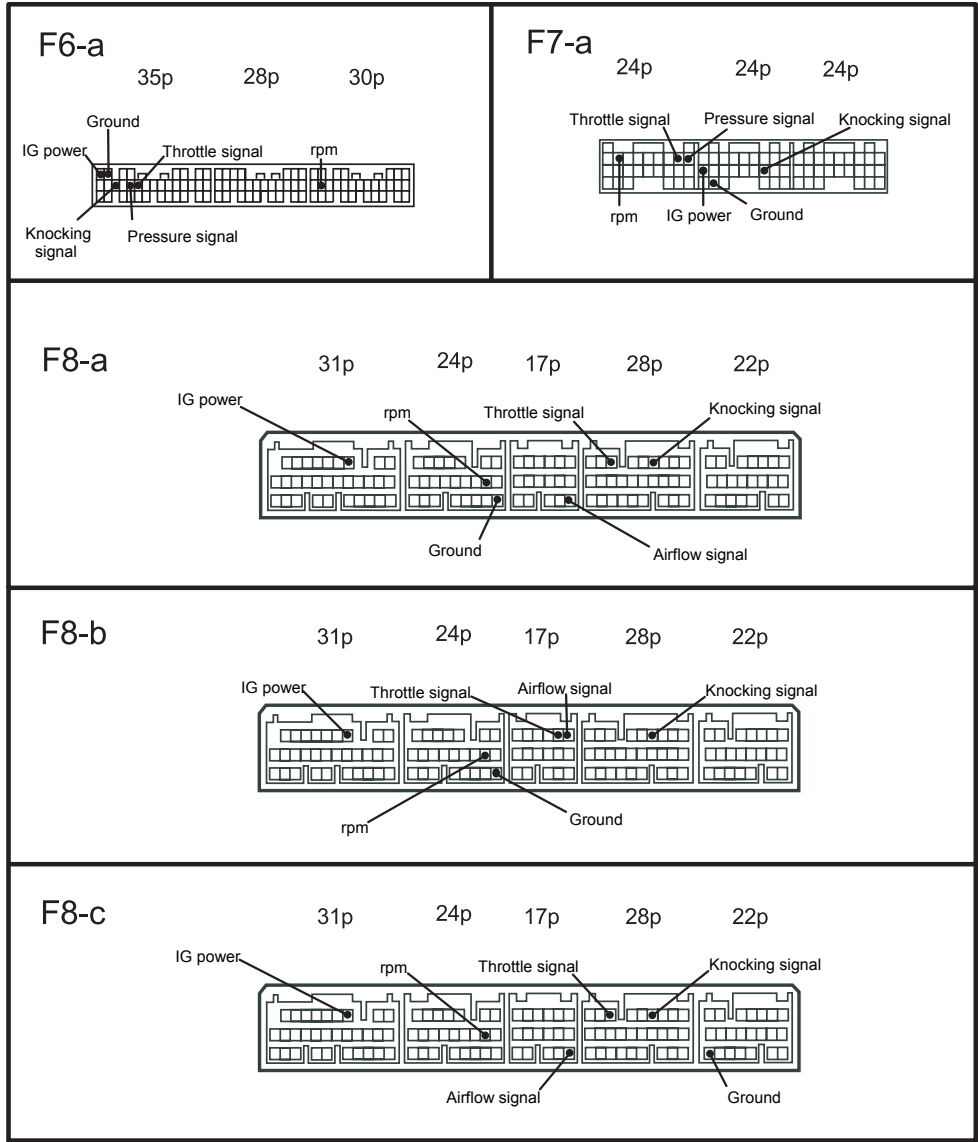

Table of Applicable Models (SUZUKI)

Explanation of sensor type indication

Example PR-3

Sensor type Sensor number

HW-Ho Wire

PR-Pressure

FL-Flap

KR-Karman

Car Name	Car Model	Engine Model	Manufacturing year	ECU Position	Remarks	Terminal Drawing	Sensor Type
ALTOWORKS	HA22S	K6A T/C	'98.10~'00.12	L	With VVT	S8-a	PR-8
						S6-a	
	HA12S	F6A T/C	'94.11~'98.9	B		S6-b	
	HA21S HB21S	K6A T/C				S3-a	
	HA11S HB11S	F6A T/C			M/T	S2-a	
				A/T	S4-a		
CAPPUCCINO	EA21R	K6A T/C	'95.5~'98.6	K		S5-a	PR-8
	EA11R	F6A T/C	'91.11~'95.10	B		S1-a	
WAGON R	MH21S	K6A T/C	'03.9~※	L	Mild Turbo		PR-17
	MC22S		'01.11~'03.8			S7-b	
			'00.12~'03.8		M/T	S6-a	
	MC12S	F6A T/C	'00.12~'01.4			A/T	S7-b
	MC21S	K6A T/C	'98.10~'00.11				S6-c
	MC11S	F6A T/C			S6-a		
	CT51S CV51S	K6A T/C	'97.4~'98.9	B		S5-a	PR-8
	CT21S CV21S	F6A T/C	'95.10~'97.10		M/T	S2-a	
			'95.10~'98.5		A/T	S4-a	
			'93.9~'95.9		M/T	S1-a	
					A/T	S4-a	
WAGON R PLUS	MA63S	K10A T/C	'99.5~'00.11	B		S9-b	PR-8
WAGON R WIDE	MA61S MB61S	K10A T/C	'97.2~'99.12	B		S5-a	PR-8
WAGON R SOLIO	MA34S	M13A	'00.12~※	B		S9-c	PR-13
	MA64S	K10A	'00.12~'02.10			S9-b	PR-8
MR WAGON	MF21S	K6A T/C	'01.11~※	L		S7-b	PR-8
		K6A				S7-a	PR-13

Car Name	Car Model	Engine Model	Manufacturing year	ECU Position	Remarks	Terminal Drawing	Sensor Type
Kei	HN22S	K6A T/C	'01.4~※	L	M/T	S6-a	PR-8
					A/T	S7-b	
	HN12S	K6A			S6-a	PR-13	
	HN21S	K6A T/C					
	HN11S	F6A T/C					
JIMNY	JB23W	K6A T/C	'98.10~※	L		S6-a	PR-8
	JA22W		'95.11~'98.9	B	M/T	S3-a	
	JA12W	F6A T/C				S2-b	
ALTO LAPIN	HE21S	K6A T/C	'03.10~※	L		S7-b	PR-17
		K6A T/C	'02.1~※			S7-a	PR-13
		K6A	'02.10~※			S7-b	PR-17
CHEVROLET CRUISE	HR51S	M13A	'01.10~※	L		S9-a	PR-13

※In some SUZUKI vehicles, A HITACHI pressure sensor is used instead of the conventional MITSUBISHI pressure sensor. If any engine malfunction or defect is detected when the sensor type mentioned in the above table is set, check the manufacturer name of the pressure sensor used in the vehicle. If the HITACHI pressure sensor is used, set the sensor type to **PR-17**

ECU Terminal Arrangement Table (SUZUKI)

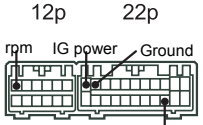
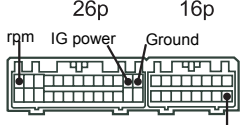
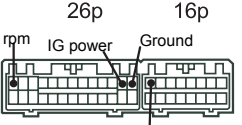
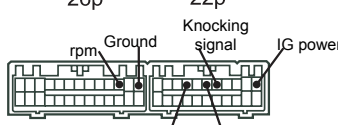
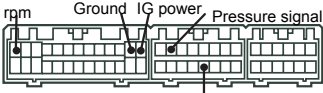
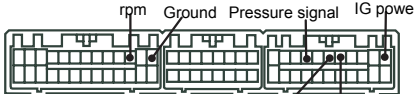
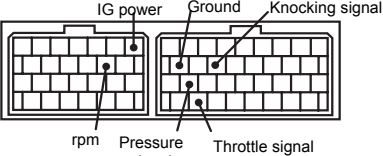
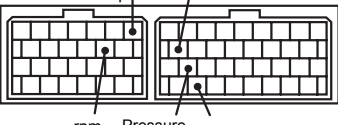
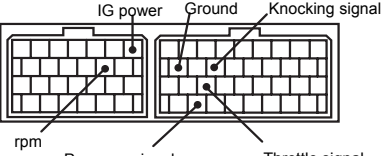
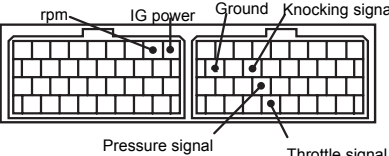
<p>S1-a</p>  <p>12p 22p rpm IG power Ground Pressure signal ※Without knocking signal and throttle signal</p>	<p>S2-a</p>  <p>26p 16p rpm IG power Ground Pressure signal ※Without knocking signal and throttle signal</p>
<p>S2-b</p>  <p>26p 16p rpm IG power Ground Pressure signal ※Without knocking signal and throttle signal</p>	<p>S3-a</p>  <p>26p 22p rpm Ground Knocking signal IG power Pressure signal Throttle signal</p>
<p>S4-a</p>  <p>26p 16p 12p rpm Ground IG power Pressure signal Throttle signal ※Without knocking signal</p>	<p>S5-a</p>  <p>26p 16p 22p rpm Ground Pressure signal IG power Throttle signal Knocking signal</p>
<p>S6-a</p>  <p>26p 34p IG power Ground Knocking signal rpm Pressure signal Throttle signal</p>	<p>S6-b</p>  <p>26p 34p IG power Ground rpm Pressure signal Throttle signal ※Without knocking signal</p>
<p>S6-c</p>  <p>26p 34p IG power Ground Knocking signal rpm Pressure signal Throttle signal</p>	<p>S7-a</p>  <p>34p 34p rpm IG power Ground Knocking signal Pressure signal Throttle signal</p>

S7-b

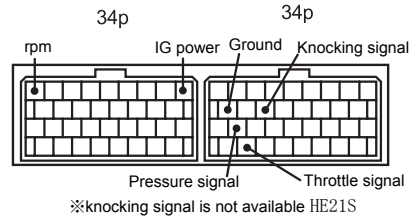

S8-a

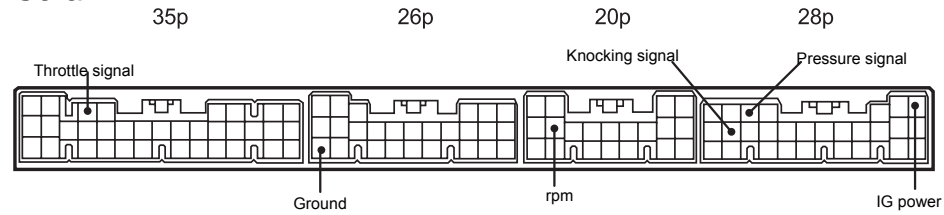

S9-a

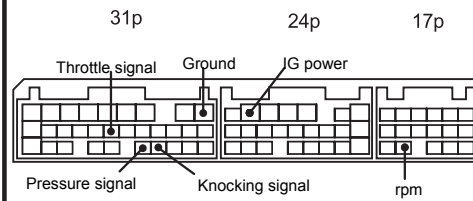

S9-b

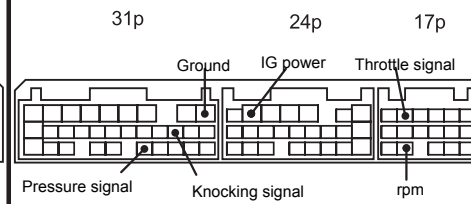

S9-c

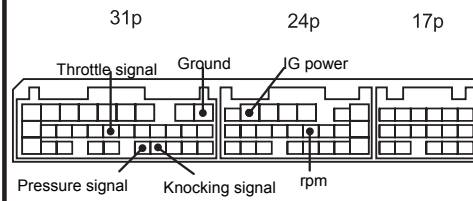

Table of Applicable Models (DAIHATSU)

Explanation of sensor type indication
 Example PR-3
 Sensor type Sensor number

HW-Hot Wire FL-Flap
 PR-Pressure KR-Karman

Car Name	Car Model	Engine Model	Manufacturing year	ECU Position	Remarks	Terminal Drawing	Sensor Type	
MIRA AVY	L260S L250S	EF-DET	'02.12~※	D		D5-a	PR-8	
MIRA	L710S L700S	EF-DET	'98.10~'00.9	D		D2-a	PR-8	
MIRA TR-XX	L512S L502S	JB-JL	'94.9~'98.9	D		D1-a	PR-8	
MOVE	L152S	JB-DET	'02.10~※	D		D5-a	PR-15	
	L160S L150S	EF-DET					PR-8	
	L900S					D3-a		
						D4-a		
	L902S	JB-DET	'01.10~'02.9				D3-a	PR-15
	L910S	EF-DET					PR-8	
	L902S	JB-DET	'98.10~'01.9				D4-a	PR-15
	L910S	EF-DET					PR-8	
L602S	JB-JL	'95.8~'98.9			D1-a			
COPEN	L880K	JB-DET	'02.6~※	D		D3-a	PR-15	
MAX	L952S	JB-DET	'01.10~※	D		D3-a	PR-15	
	L960S	EF-DET					PR-8	
BOON	M300S	1KR-FE	'04.6~※	D		D5-b	PR-20	

ECU Terminal Arrangement Table (DAIHATSU)

<p>D1-a</p> <p>26p 16p 12p</p> <p>Ground IG power Pressure signal</p> <p>rpm Knocking signal</p> <p>※Without throttle signal</p>	<p>D2-a</p> <p>31p 24p 17p</p> <p>Ground Pressure signal IG power</p> <p>Throttle signal Knocking signal rpm</p>
<p>D3-a</p> <p>31p 24p 17p 22p</p> <p>Pressure signal IG power</p> <p>Ground Knocking signal Throttle signal rpm</p>	<p>D4-a</p> <p>31p 24p 17p</p> <p>Ground IG power</p> <p>Throttle signal Pressure signal rpm</p> <p>Knocking signal</p>
<p>D5-a</p> <p>34p 35p 35p 31p</p> <p>Pressure signal Throttle signal IG power</p> <p>Ground Knocking signal rpm</p>	<p>D5-b</p> <p>34p 35p 35p 31p</p> <p>IG power Ground Pressure signal</p> <p>rpm Throttle signal Knocking signal</p> <p>※ Set the number of cylinders "1" at initial setting. [etc.→Car sel.→Cyl]</p>

Notes

1. The contents of this document are subject to change without prior notice.
2. The contents of this document have been prepared with extreme care. However, if you find an error or any fault, please contact us with any issues.
3. A part or all of this document may not be reproduced in any form without prior written permission, and also may not be used without the prior written permission of APEX CO., LTD. under the copyright except for private use.

- The company names and product names described in this document are the registered trademarks or brands of the respective companies
- The names, addresses and telephone numbers mentioned as where to contact are as of July 13, 2010. Note that this information is subject to change.

■ Revision Record

No.	Date of issue	Part No. of instruction manual	Edition	Change of description
1	Dec. 10, 2002	7107-0240-00	First edition	
2	May. 1, 2003	7107-0240-01	2nd edition	
3	Jun. 1, 2004	7107-0240-02	3rd edition	
4	Sep. 30, 2004	7107-0240-03	4th edition	
5	July 13, 2010	7107-0240-04	5th edition	

Head office:

APEX Co., LTD.
5-21-13 2F, Fujimi
Sagamihara City, Kanagawa Pref.,
JAPAN 229-0036
ph+81-42-778-3991 fx+81-42-778-4495

USA office:

APEX Integration, Inc.
1449 W. Orange Grove Ave., Unit A
Orange, CA 92868

www.apexi.com