

SUPER ITC

SUPER IGNITION TIMING CONVERTER

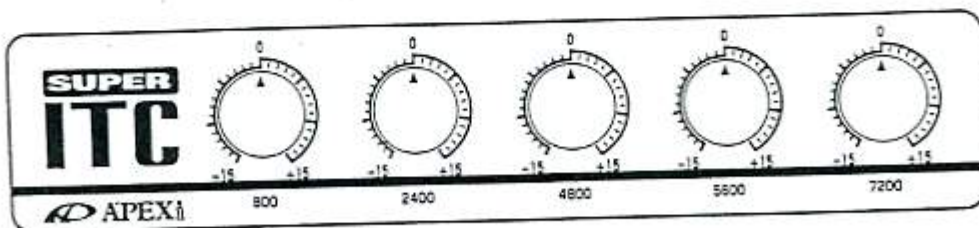

 **APEX**ⁱ

1

Introduction

Thank you for purchasing the A'PEXi SUPER ITC (Super Ignition Timing Converter).

This product allows easy adjustments of ignition timing by modifying the engine crank angle sensor signal.







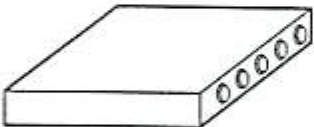
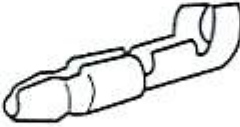

The ECU (Engine Control Unit) receives the crank angle sensor signal and determines crank angle position. The ECU then determines the correct ignition timing for the spark plugs. This unit modifies the crank angle sensor signal output and allows the ignition timing to be modified.

CAUTION!

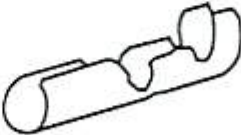
- * This unit may not be installed or used on any vehicle which is not listed in this manual.
- * Please do not use this unit for any other purpose than the functions stated above.
- * Please be sure to thoroughly read this instruction manual before attempting installation.

2

Parts List

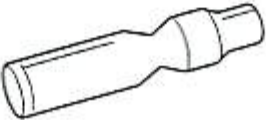
<p>1. Control Unit 1</p> 	<p>5. Male Connector 6</p> 	<p>9. Splitting Tap 2</p> 
<p>2. Single Harness 1</p> 	<p>6. Female Connector 6</p> 	<p>10. Instruction Manual 1</p> 
<p>3. Splitting Tap Harness 1</p> 	<p>7. Male Connector Sleeve 6</p> 	<p>11. Double Sided Tape 1</p> 
<p>4. Splitting Tap Harness 1</p> 	<p>8. Female Connector Sleeve 6</p> 	

3

Part Names

Front Side

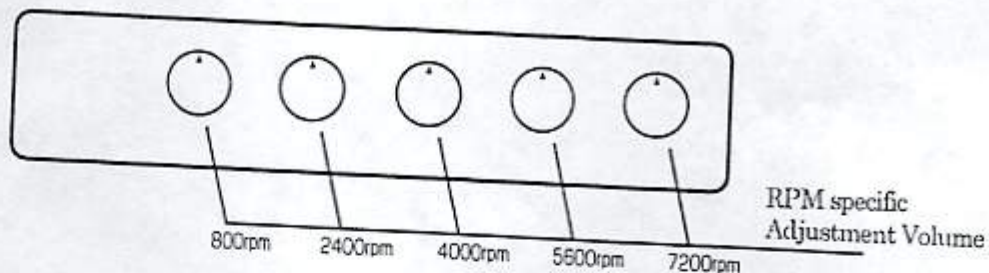

Back Side

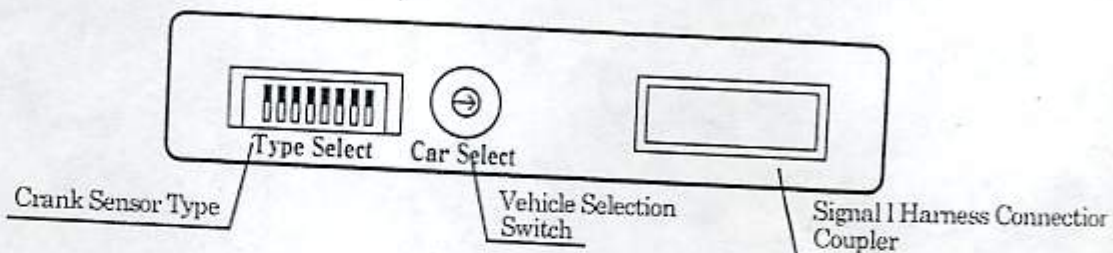

4

For the Installer

Warning!

- * Please be sure to disconnect the negative terminal of the battery before installation.
- * Please mount the unit in the vehicle approx. 50 cm away from the reach of the driver or at a distance where the driver cannot adjust the unit while the vehicle is in motion.
- * Please be sure to secure all unused connectors with electrical tape.

[1] Installation

1. Disconnect the negative terminal of the battery
 2. Please locate the vehicle ECU location by using the Vehicle Specific ECU Location Diagram and the Vehicle Specific Wiring Diagram
 3. While referring to the Vehicle Specific Wiring Diagram connect a connector to each of the signal wires
 - * Please use a male fitting on the ECU side of the harness and a female fitting on the vehicle side of the harness
- For NISSAN vehicles, please group two of the same signal wires into one fitting connector.
4. While referring to the Vehicle Specific Wiring Diagram, please connect the red Power (+12V) signal wire. (Please refer to "How to Use the Splitting tap")
 - * Be sure to use electrical tape to secure all connections.
 5. While referring to the Vehicle Specific Wiring Diagram, please connect the black Ground signal wire. (Please refer to "How to Use the Splitting Taps")
 - * Be sure to use electrical tape to secure all connections.

6. While referring to the Vehicle Specific Wiring Diagram, please connect the correct connectors from the signal harness to the connectors from step #3.
* Please be sure to secure all unused connectors with electrical tape.
7. Reconnection the negative terminal of the battery will complete the installation.

How to Connect the Connectors

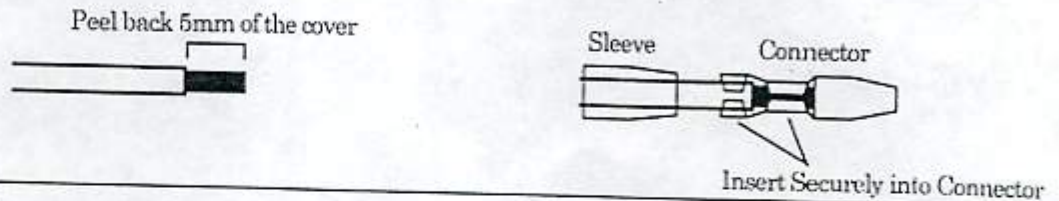

● How to Use the Splitting Taps

- ① Peel back 3mm of wire to be connected
- ② Peel back 5mm of wire to connect
- ③ Twist the two wires together
- ④ Secure the two wires with the splitting tap



* Be sure to cover the connection with electrical tape.

- [2] Please set the Vehicle Specific Selection Switch and Crank Angle Sensor Type Switch on the back side of the unit by referring to the Vehicle Specific Wiring Diagram.

: Setting the Crank Angle Sensor Type

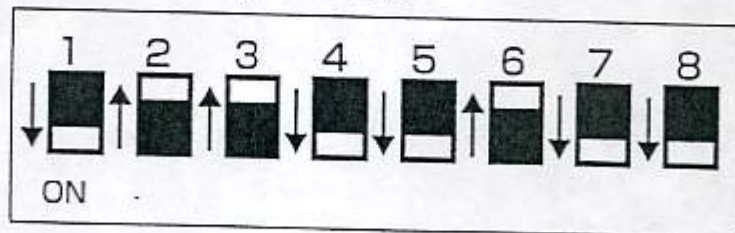

Ex: Fairlady Z

Type Select

Please slide the switch towards the white mark

- [3] Once the engine has been started, the ignition timing can be adjusted.

5

Product Functions

[1] The engine has various sensors to identify what position each piston and connecting rod is at .
Sensors vary according to manufacture but they all use either 2 or 3 sensors.

This unit modifies the out put signal timing from these sensors and inputs the new signal into the ECU. This allows the ignition timing to be adjusted.

For example, if the factory ignition timing is set to +20 degrees, the ECU determines the timing from the crank sensor output to TDC(Top Dead Center Position) and fires the ignition 20 degrees before.

By using the Super ITC in this situation with the volume at +5 degrees, the Super ITC advances the sensor output an extra 5 degrees and sends the new signal to the ECU.

The ECU takes the new modified signal and bases its output on the factory setting of 20 degrees and ends up producing a 25 degree actual output.

CAUTION! * Please be aware that the adjustment volumes modify ignition timing based on the factory settings. The volume knob positions *DO NOT* represent the actual ignition timing figures.

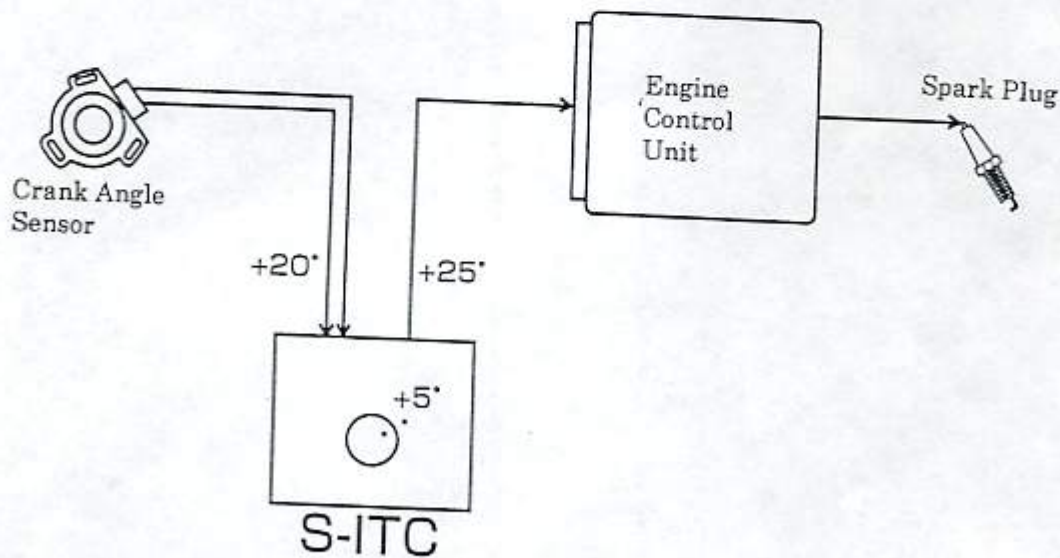

[2] RPM Specific Adjustments

The Super ITC allows the user to adjust the ignition timing with the aid of 5 RPM specific volume knobs on the face of the unit.

The RPM ranges include 800, 2400, 4000, 5600, 7200rpm. Each knob allows adjustments in 1 degree increments with a maximum of ± 15 degrees. Timing between each RPM knob is determined by the variation between the setting of the previous knob.

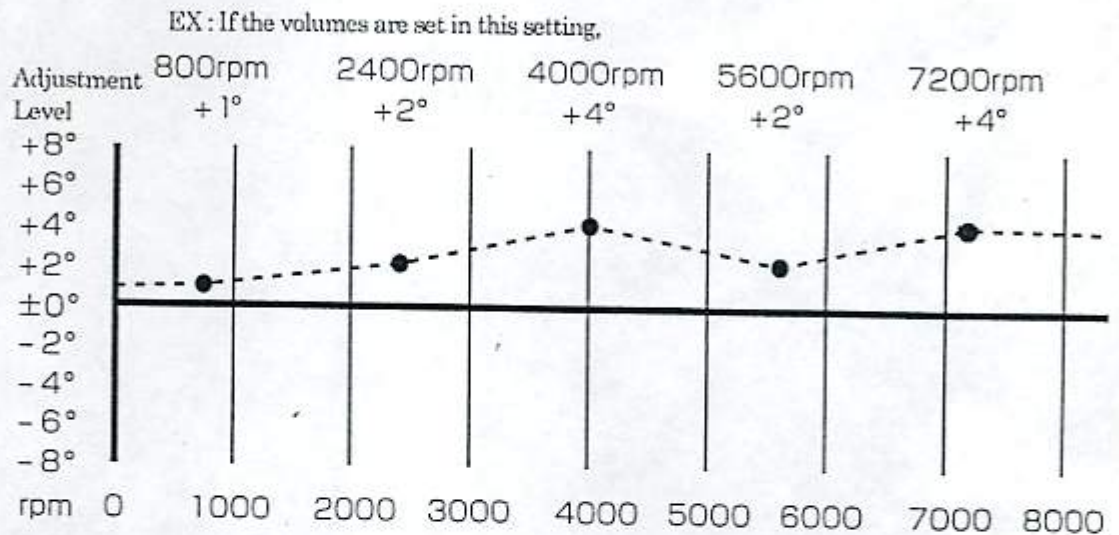

[3] Adjustment Control Feature

By switching the No. 1 switch of the Crank Angle Sensor Type Switch on the back of the unit, the maximum adjustment of ignition timing becomes ± 5 degree. Even if the volume has been turned up beyond ± 5 degrees, the ignition timing will not exceed ± 5 degrees.

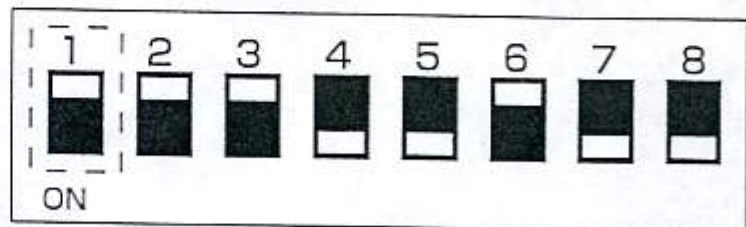
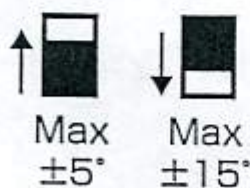

Type Select

S-ITC TYPE SELECT SWITCH SETUP

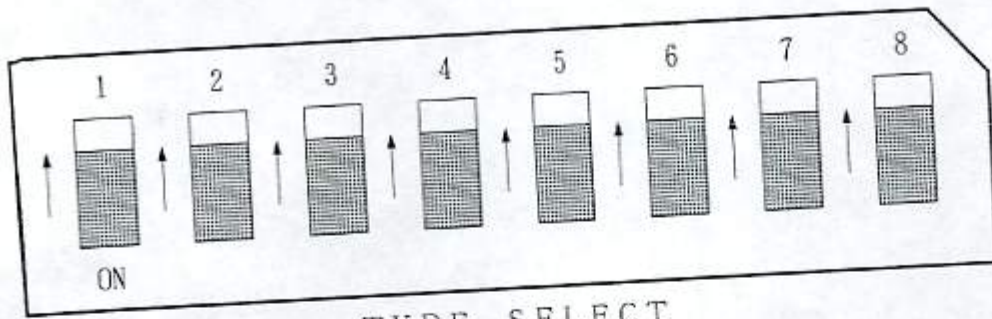

INITIAL SETUP

TYPE SELECT

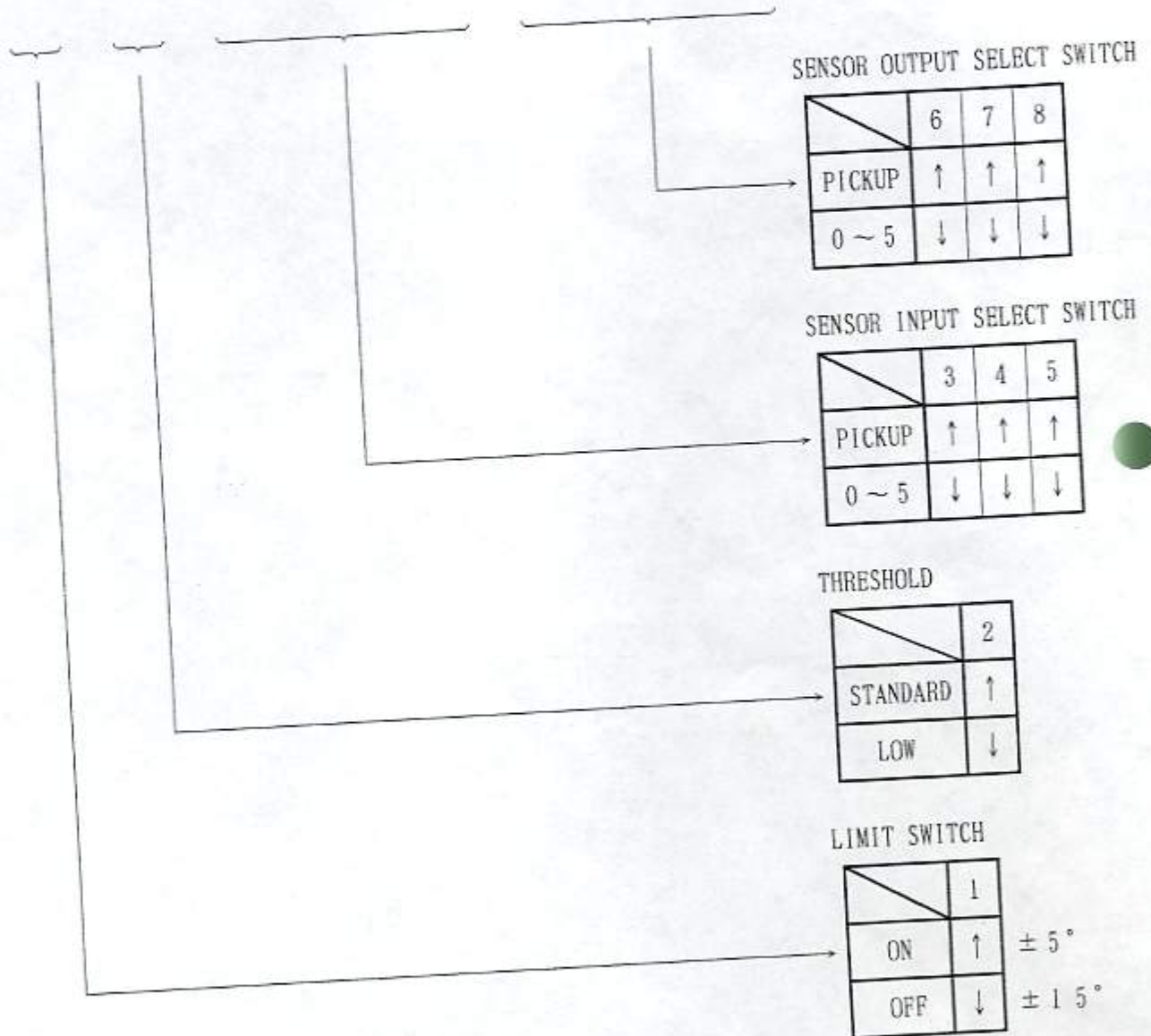

6

Volume Knob Operation

1. Turning the volume knob to the right (clockwise) will advance the timing. 1 notch represents 1 degree of advance with a maximum of 15 degrees.

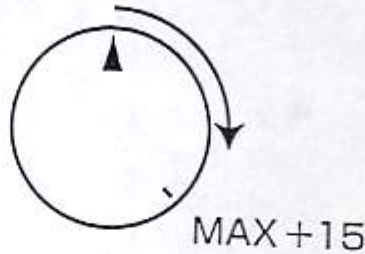

2. Turning the volume knob to the left (counter-clockwise) will retard the timing. 1 notch represents 1 degree of retard with a maximum of 15 degrees.

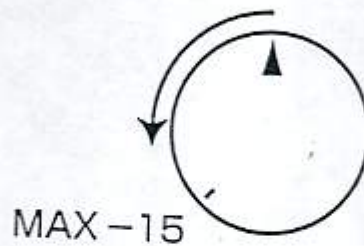
**Warning!**

- * Advancing of the ignition timing may cause knocking or detonation which may cause destructive damage to the engine. Please be sure to set the ignition timing so that detonation or knocking **KOES NOT** occur.
- * Retarding of the ignition timing may cause the exhaust gas temperature to rise dramatically causing extreme damage to the engine and turbo. Please be sure to set the ignition timing so that the exhaust gas temperature **DOES NOT** rise excessively.

7

Vehicle Specific ECU Wiring Diagram

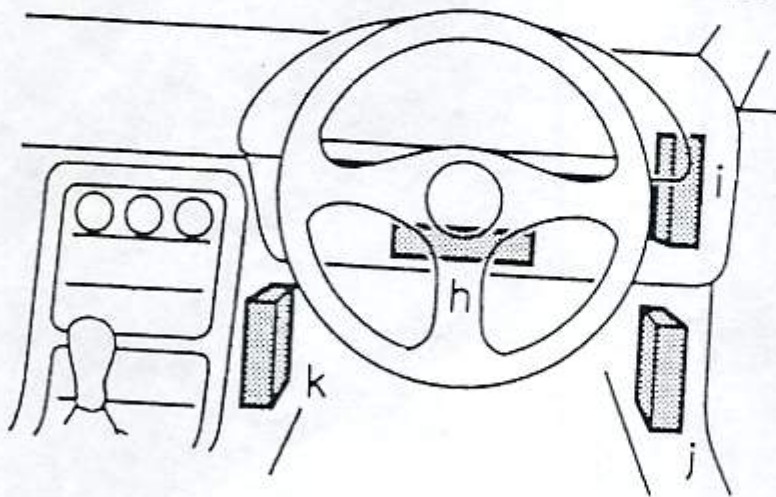
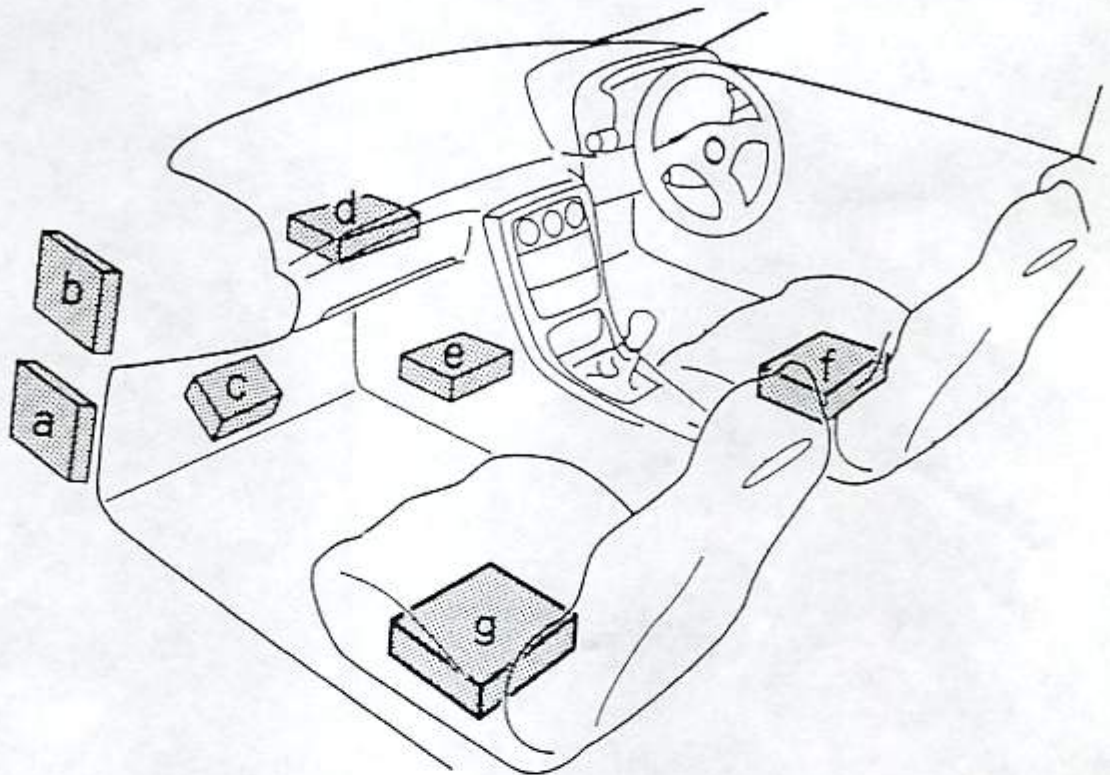

*This Arrangement of ECU is for only Right Handle Car.

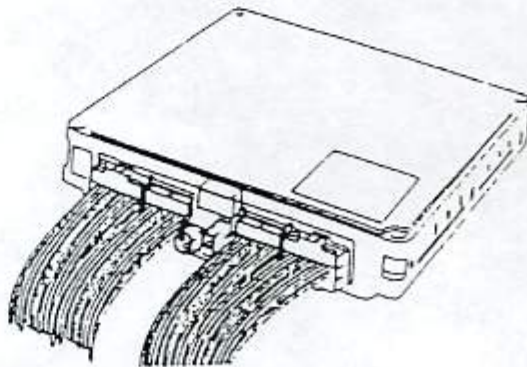
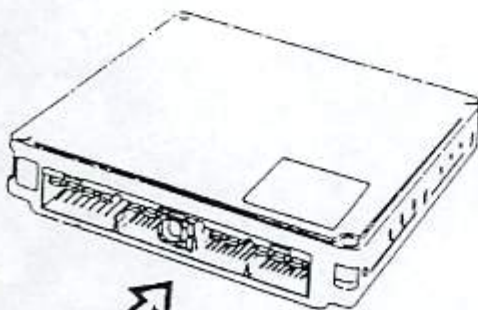

*The Following Diagrams View the Coupler from the Same Angle as the Diagram.
Please be Careful Not to make Improper Connections or Short Out the Unit.

MAZDA

Vehicle	Code	Engine Type	Year	ECU 場所	Type Select SW	Car Sel SW
Roadster	NA8C	BP-ZE	'95.8~	c	<input type="checkbox"/> <input type="checkbox"/> <input type="checkbox"/> <input type="checkbox"/> <input type="checkbox"/> <input type="checkbox"/> <input type="checkbox"/> <input type="checkbox"/> <input type="checkbox"/> <input type="checkbox"/>	C

* The No.1 dip-switch on the left side is to limit timing adjustments

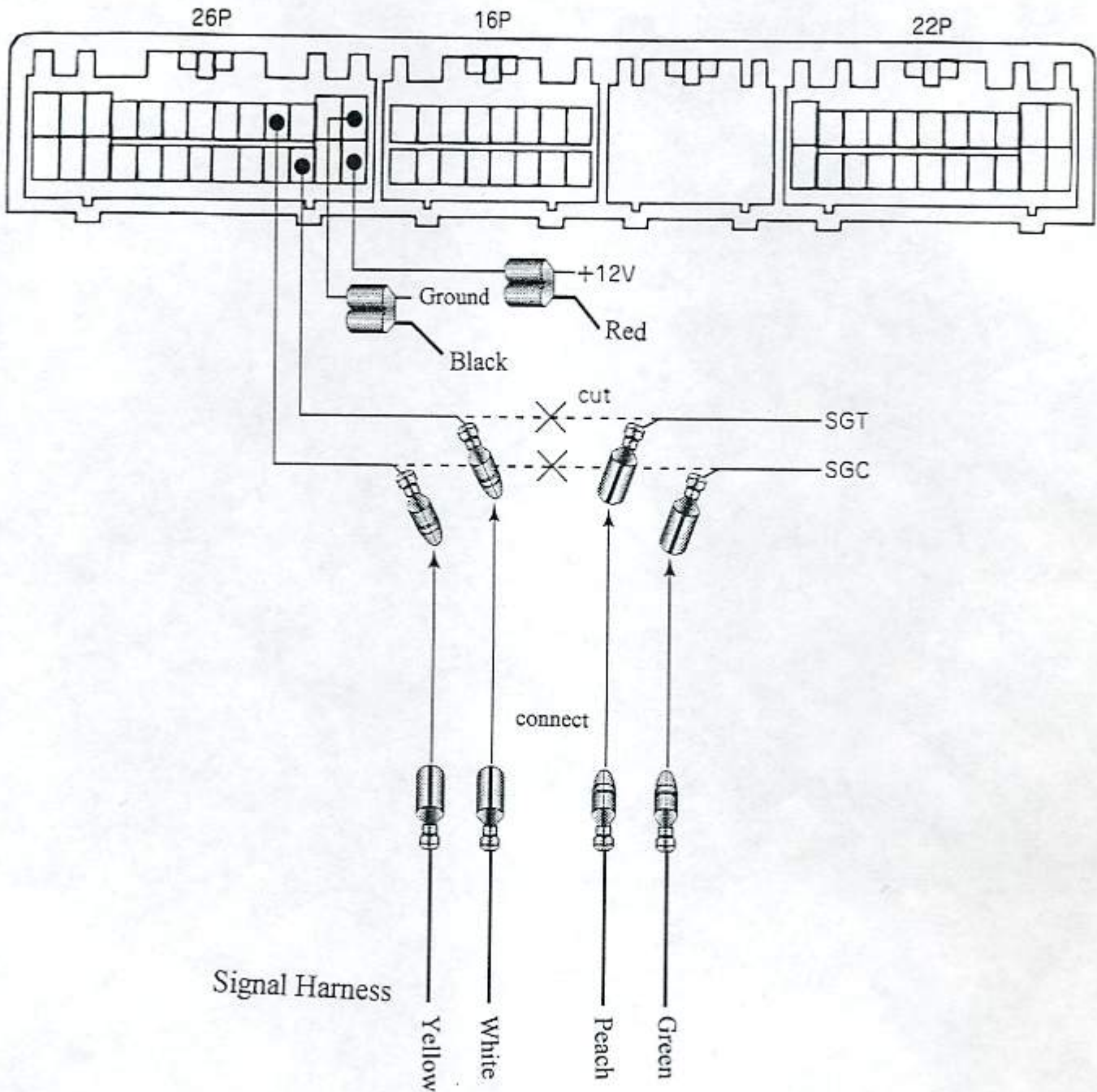



APEX Integration, Inc.

130 McCormick Ave., Suite 107, Costa Mesa, CA 92626
Tel: (714) 444-4378 Fax (714) 444-4379

MITSUBISHI

Vehicle	Code	Engine Type	Year	ECU 場所	Type Select SW	Car Sel SW
Eclipse Turbo	D22/27A	4G63	89-94	b		C

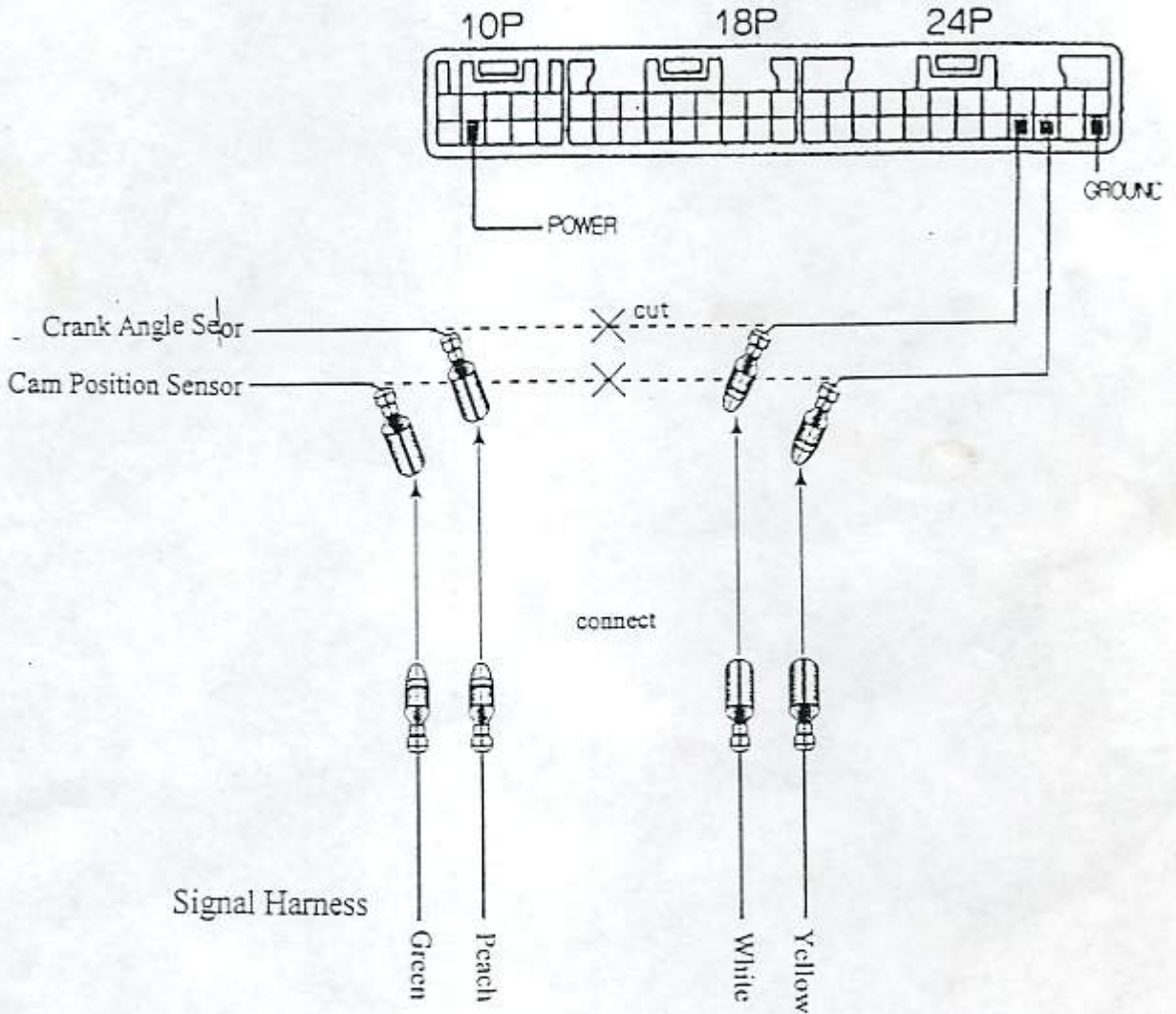

89-94 Mitsubishi Eclipse GS-T/GSX Super ITC Wiring

HONDA

Vehicle	Code	Engine Type	Year	ECU 場所	Type Select SW	Car Sel SW
Integra	DC2(A/T)	B18C	'95.9~	a	<input type="checkbox"/> <input type="checkbox"/> <input type="checkbox"/> <input type="checkbox"/> <input type="checkbox"/> <input type="checkbox"/> <input type="checkbox"/> <input type="checkbox"/>	4

* The No.1 dip-switch on the left side is to limit timing adjustments

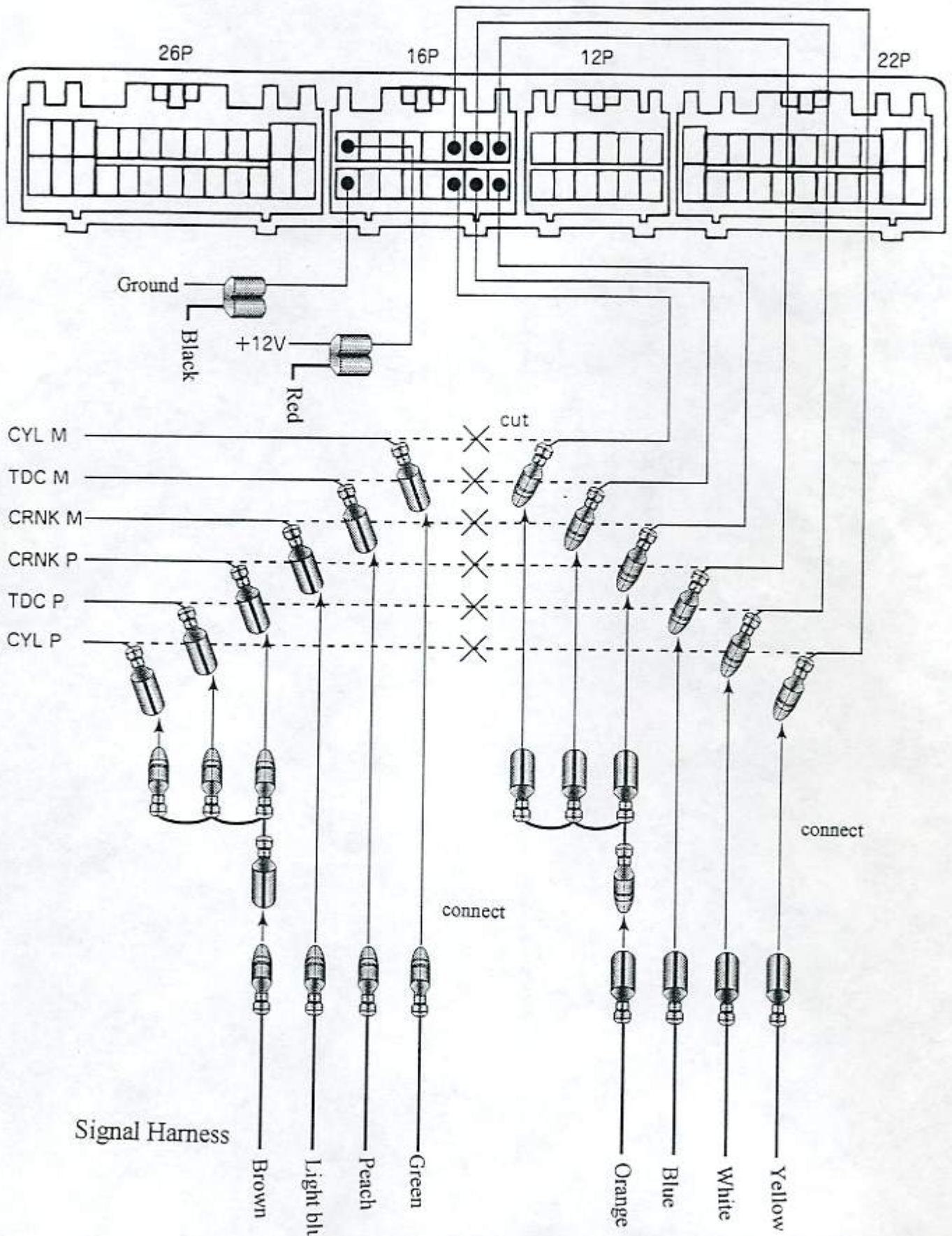

HONDA

Vehicle	Code	ECU Location	Year	ECU 場所	Type Select SW	Car Sel SW
Odyssey	RA1,2	F22B	'94.9~	c		4
Civic	EG6	B16A	'91.9~'95.9	a		4

* The No.1 dip-switch on the left side is to limit timing adjustments

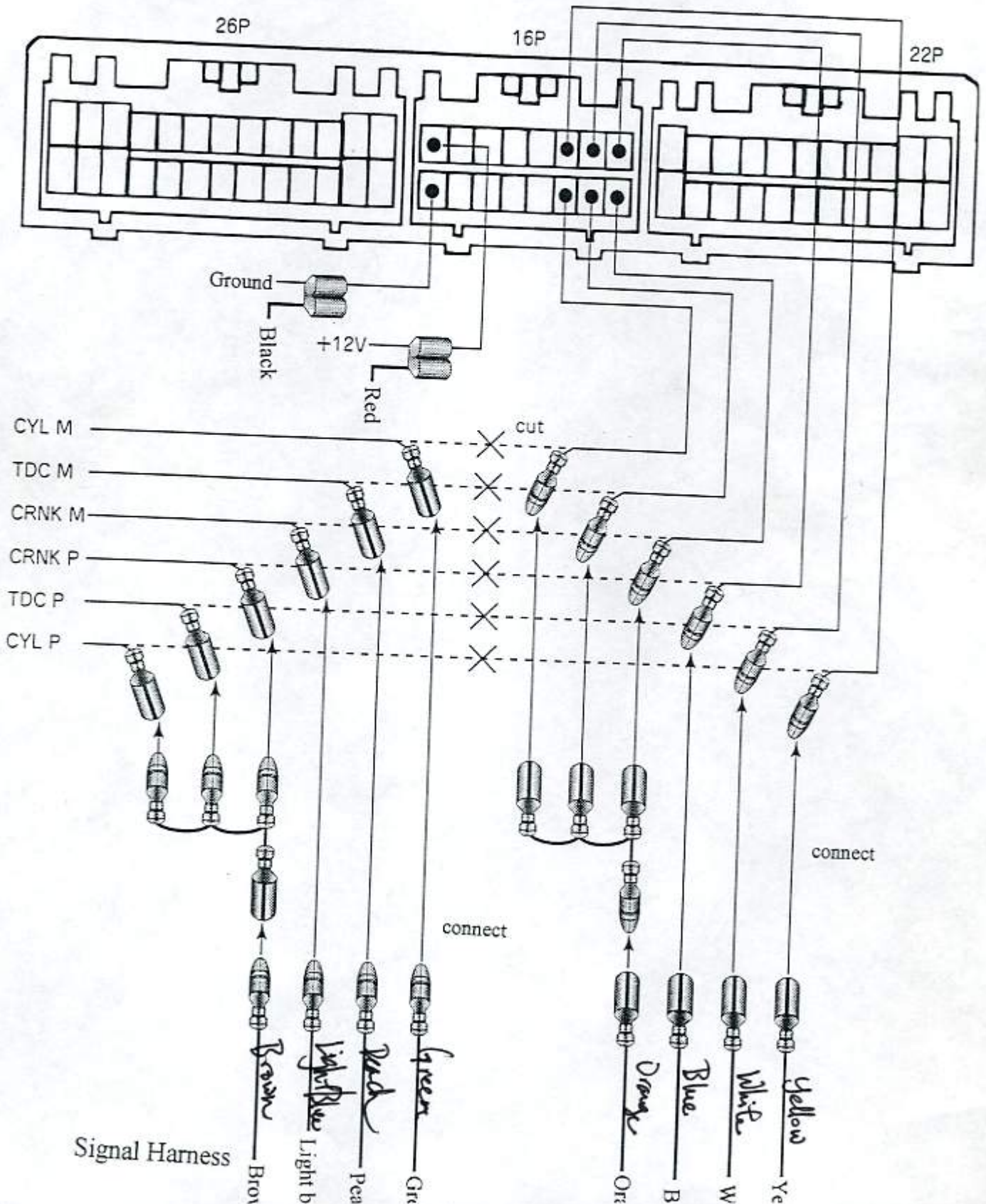

TOYOTA

Vehicle	Code	Engine Type	Year	ECU 場所	Type Select SW	Car Sel SW
Supra	MA70	7M-GTE	'88.8~'90.7	d		0
Soarer	MZ20	7M-GTE	'88.1~'91.4	d		0
Supra	GA70	1G-GTE	'88.8~'93.4	d		0
Soarer	GZ20	1G-GTE	'98.1~'91.4	d		0
MR-2	SW20	3S-GTE	'89.10~'91.2	トランク前		0
Celica	ST185	3S-GTE	'89.9~'94.2	e		0
Levin*Trueno	AE92	4A-GZE	'89.5~'91.5	e		0

* The No.1 dip-switch on the left side is to limit timing adjustments

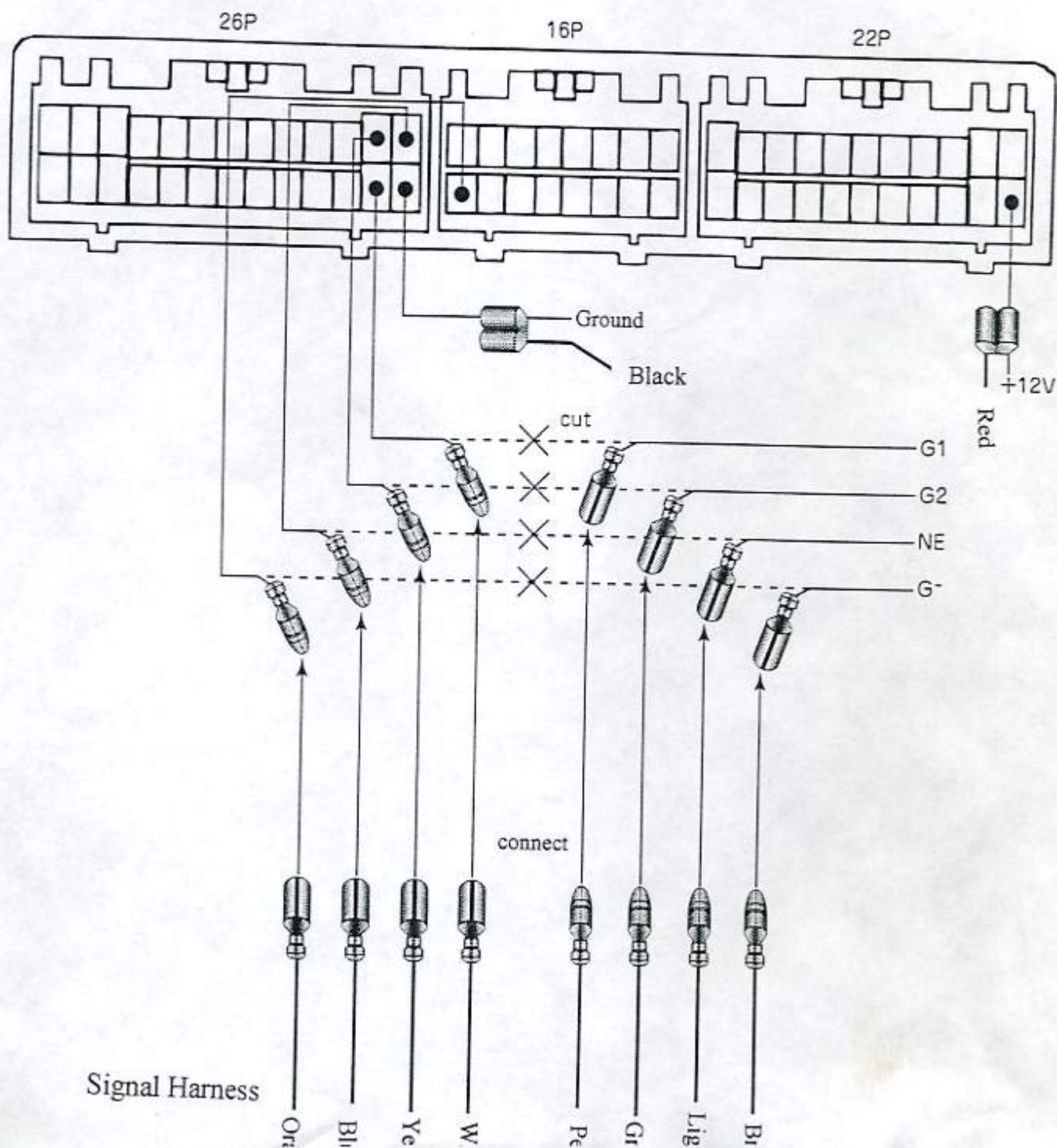

TOYOTA

Vehicle	Code	Engine Type	Year	ECU 場所	Type Select SW	Car Sel SW
Soarer	JZZ30	1JZ-GTE	'91.5~'96.8	C	<input type="checkbox"/> <input type="checkbox"/> <input type="checkbox"/> <input type="checkbox"/> <input type="checkbox"/> <input type="checkbox"/> <input type="checkbox"/> <input type="checkbox"/> <input type="checkbox"/> <input type="checkbox"/>	0

* The No.1 dip-switch on the left side is to limit timing adjustments

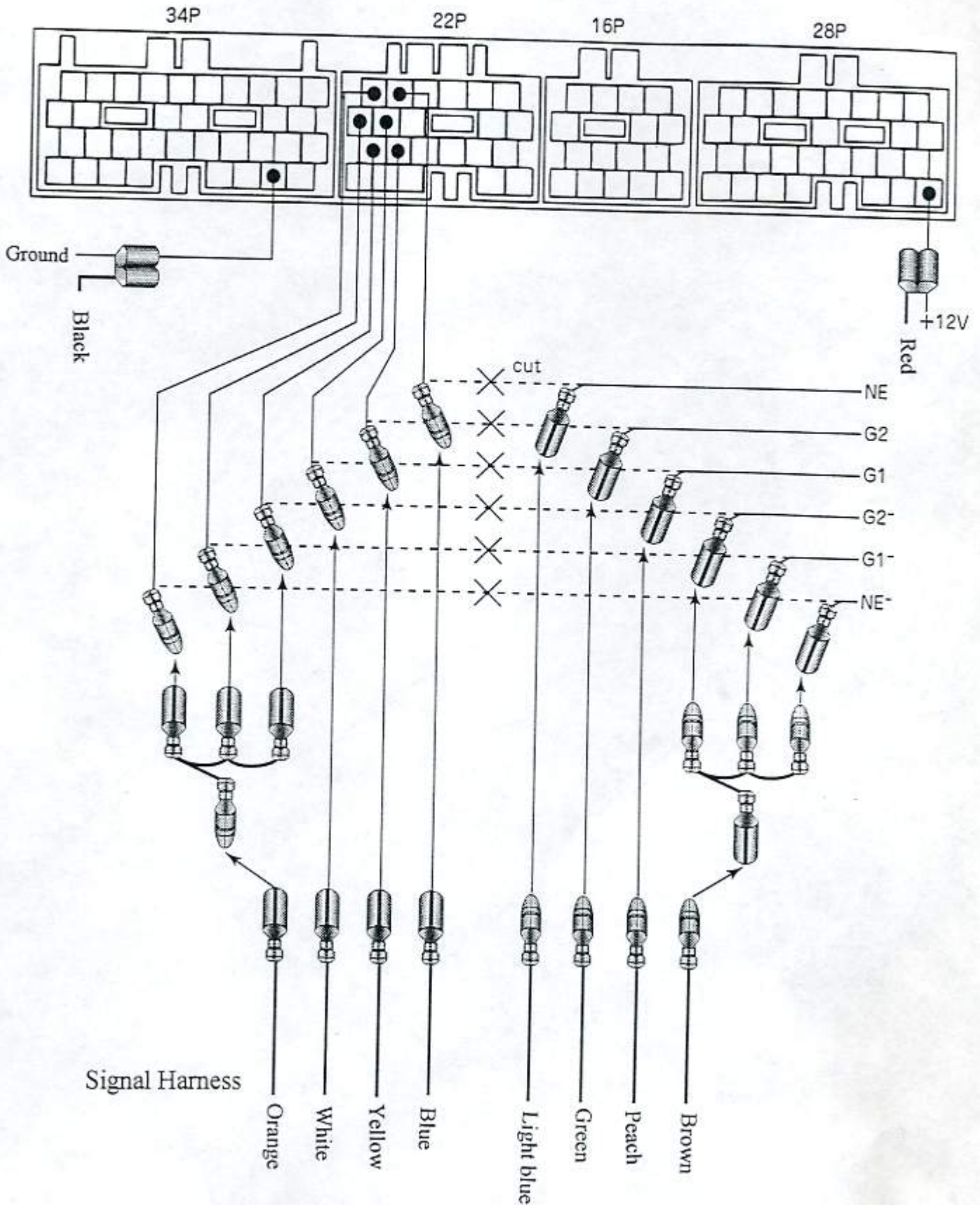

NISSAN

Vehicle	Code	Engine Type	Year	ECU 場所	Type Select SW	Car Sel SW
300ZX	Z32	VG30DETT	'89.7~'97.1	c		8
Skyline GT-R	BCNR33	RB26DETT	'89.8~'95.1	a		8
Skyline GT-R	BNR32	RB26DETT	'95.1~'97.1	a		8
Skyline	R33	RB25DET	'93.8~'96.1	a		8
Skyline	R32	RB20DET	'89.5~'93.8	a		8
Silvia	S14	SR20DET	'93.10~'96.6	a		7
Silvia	S13	CA18DET	'88.5~'91.1	a		7
180SX	RS13	CA18DET	'89.3~'91.1	a		7

* The No.1 dip-switch on the left side is to limit timing adjustments

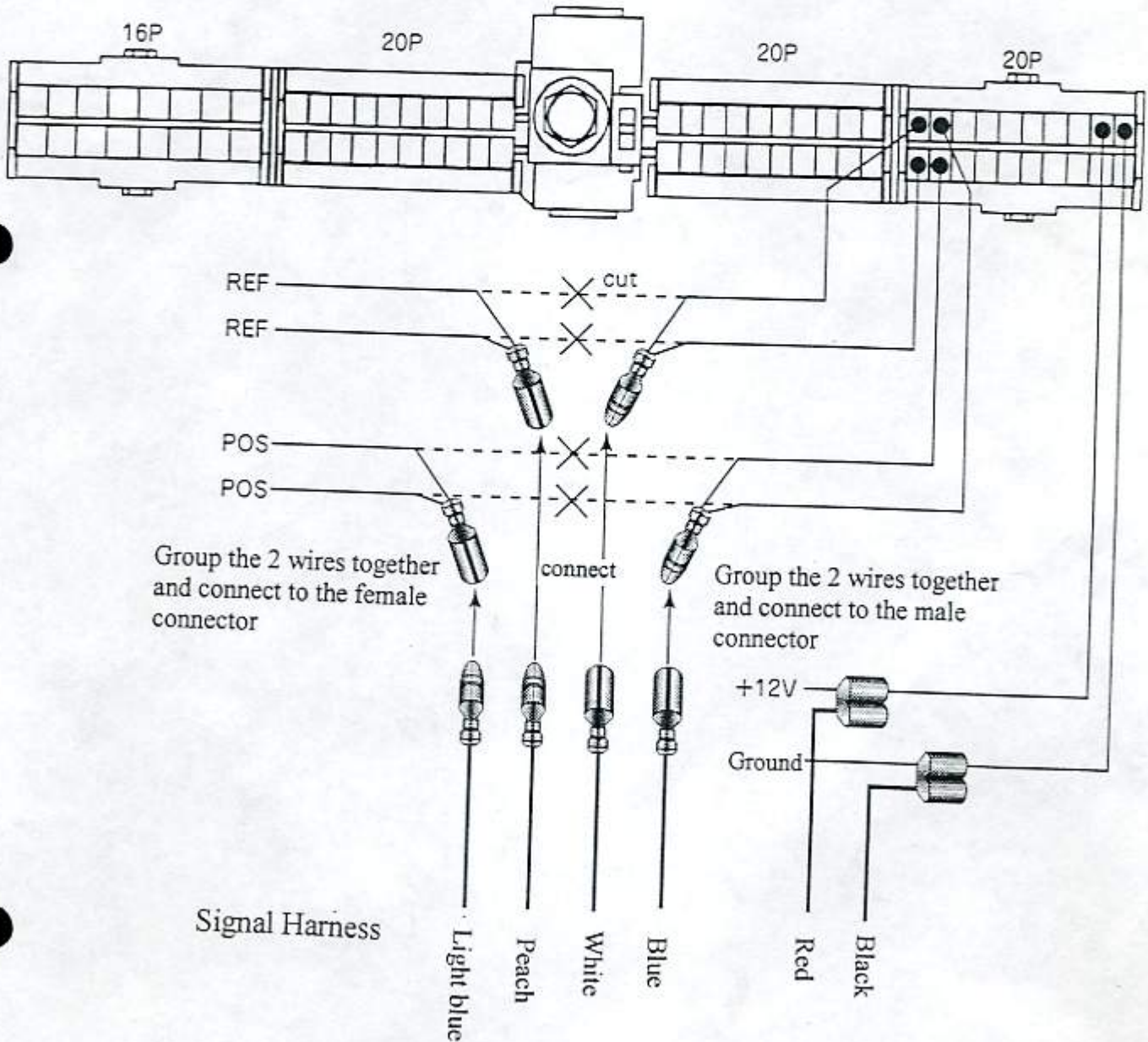

NISSAN

Vehicle	Code	Engine Type	Year	ECU 場所	Type Select SW	Car Sel SW
300ZX	Z32	VG30DETT	'89.7~'97.1	c		8
Skyline GT-R	BCNR33	RB26DETT	'89.8~'95.1	a		8
Skyline GT-R	BNR32	RB26DETT	'95.1~'97.1	a		8
Skyline	R33	RB25DET	'93.8~'96.1	a		8
Skyline	R32	RB20DET	'89.5~'93.8	a		8
Silvia	S14	SR20DET	'93.10~'96.6	a		7
Silvia	S13	CA18DET	'88.5~'91.1	a		7
180SX	RS13	CA18DET	'89.3~'91.1	a		7

* The No.1 dip-switch on the left side is to limit timing adjustments

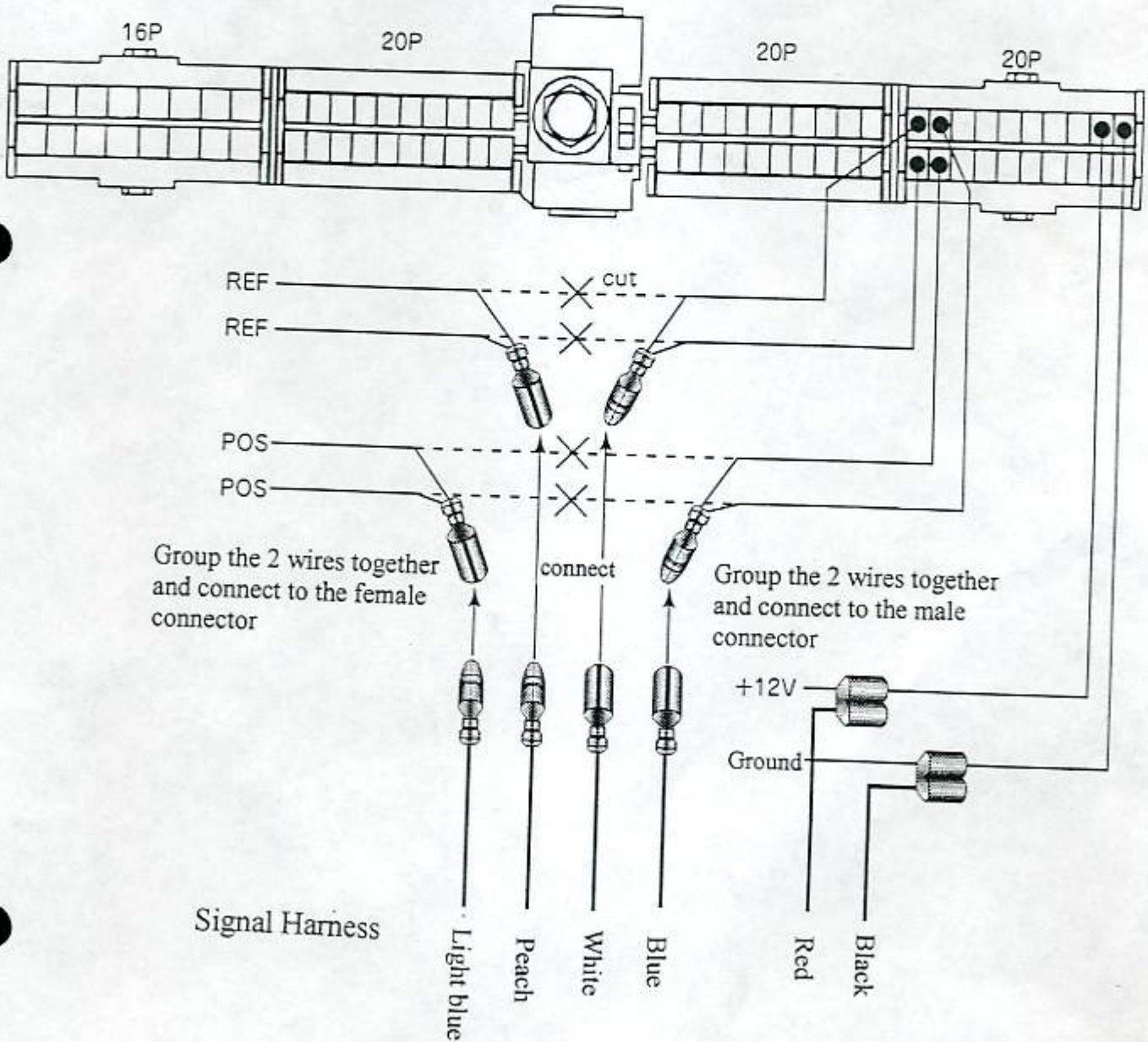

NISSAN

Vehicle	Code	Engine Type	Year	ECU 場所	Type Select SW	Car Sel SW
Stagia	WGNC34	RB25DET	'96.9~	a	<input type="checkbox"/> <input type="checkbox"/> <input type="checkbox"/> <input type="checkbox"/> <input type="checkbox"/> <input type="checkbox"/> <input type="checkbox"/> <input type="checkbox"/>	8

* The No.1 dip-switch on the left side is to limit timing adjustments

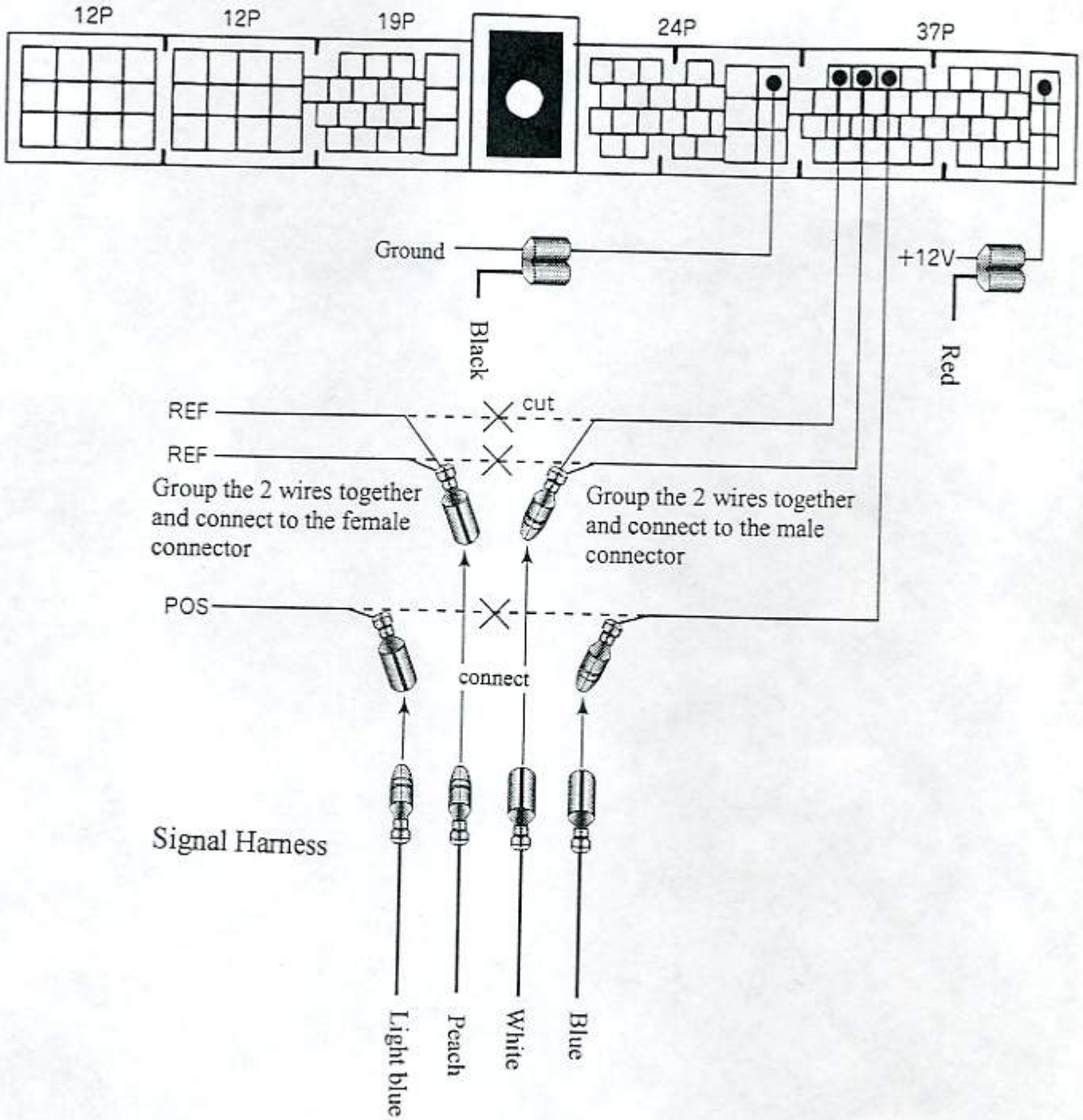

NISSAN

Vehicle	Code	Engine Type	Year	ECU 場所	Type Select SW	Car Sel SW
Stagia	WGNC34	RB25DET	'96.9~	a	<input type="checkbox"/> <input type="checkbox"/> <input type="checkbox"/> <input type="checkbox"/> <input type="checkbox"/> <input type="checkbox"/> <input type="checkbox"/> <input type="checkbox"/>	8

* The No.1 dip-switch on the left side is to limit timing adjustments

